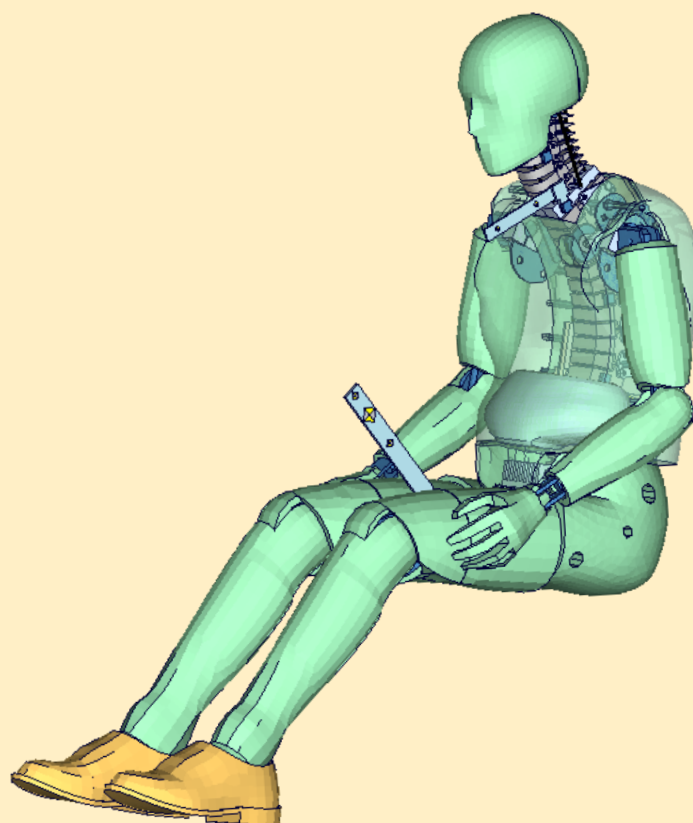


# Documentation

## LS-DYNA

### BioRID-II - Version 4.0.1



#### **User's Manual**

Manual Release 0.0 for Model 4.0.1  
24 September 2021

DYNAmore GmbH  
[www.dynamore.de](http://www.dynamore.de)  
Germany

Authors:  
Sebastian Stahlschmidt  
Yupeng Huang

Contact Address:  
DYNAmore GmbH  
Industriestr. 2  
70565 Stuttgart  
Germany  
Tel: +49-(0)711-459600-0  
[support@dynamore.de](mailto:support@dynamore.de)

Copyright 2021 DYNAmore GmbH

# Content

<b><u>1. KEYWORDS USED</u></b>	<b>- 7 -</b>
<b><u>2. EXTRACTION OF OCCUPANT INJURY CRITERIA</u></b>	<b>- 9 -</b>
2.1 ACCELEROMETERS	- 9 -
2.2 HEAD ACCELERATION	- 10 -
2.3 SPINE ACCELERATIONS	- 11 -
2.4 PELVIS ACCELERATION	- 12 -
2.5 NECK LOAD CELLS	- 13 -
2.6 PELVIS INTERFACE LOAD CELL	- 14 -
2.7 FORCE BETWEEN HEAD AND HEAD REST	- 15 -
<b><u>3. LICENSE FILE</u></b>	<b>- 16 -</b>
<b><u>4. INCORPORATING THE DUMMY IN SEAT MODELS</u></b>	<b>- 18 -</b>
4.1 POSITIONING, TREE FILE	- 18 -
4.2 POSITIONING FILE	- 20 -
4.3 HEAD POSITION ADJUSTMENT	- 21 -
4.4 REPAIRING SEATBELT ELEMENTS	- 22 -
4.5 COMMON WORKFLOW FOR POSITIONING UNDER GRAVITY LOAD	- 22 -
4.6 NUMBERING	- 22 -
4.7 CONTACT DEFINITION	- 23 -
4.8 ADDITIONAL REMARKS	- 24 -
4.9 PRESTRESSED COMPONENTS OF THE BIORID	- 25 -
4.10 RELEASE NOTES	- 26 -
4.10.1 RELEASE NOTES FROM V4.0 TO V4.0.1	- 26 -
4.10.2 RELEASE NOTES FROM V3.9 TO V4.0	- 26 -
4.10.3 RELEASE NOTES FROM V3.8 TO V3.9	- 28 -
4.10.4 RELEASE NOTES FROM V3.6 TO V3.8	- 28 -
4.10.5 RELEASE NOTES FROM V3.1 TO V3.6	- 29 -
4.10.6 RELEASE NOTES FROM V3.0 TO V3.1	- 30 -
4.10.7 RELEASE NOTES FROM V2.5 TO V3.0	- 31 -
4.10.8 RELEASE NOTES FROM V2.0 TO V2.5	- 32 -
4.10.9 RELEASE NOTES FROM V1.5 TO V2.0	- 33 -
<b><u>5. FUTURE WORK</u></b>	<b>- 34 -</b>
<b><u>6. MATERIAL TESTS</u></b>	<b>- 35 -</b>
<b><u>7. PERFORMANCE</u></b>	<b>- 37 -</b>
7.1 SLED TEST WITH SPINE ONLY	- 37 -
7.1.1 RESULTS OF SPINE FIXED UP TO T1	- 38 -
7.1.2 RESULTS OF SPINE FIXED UP TO T8	- 43 -

---

7.1.3	RESULTS OF SPINE FIXED UP TO L6	- 48 -
7.2	<b>GUIDED SLED CALIBRATION TEST RESULTS</b>	<b>- 54 -</b>
7.3	<b>PELVIS TEST RESULTS</b>	<b>- 56 -</b>
7.4	<b>SPORTS CAR SEAT RESULTS</b>	<b>- 59 -</b>

## 1. General information

The development and validation has been performed on different platforms. The following LS-DYNA versions have been used:

LS-DYNA Version	Revision Nr.	SVN Version
R9.3	143600	143600
R9.3	618-gee79cb9	-
R11	3432-g39eef2f6a9	-
R12	2791-gfdd0b74962	-

**Table 1:** LS-DYNA Versions.

With the version 4.0 of the BioRID-2 model the following keyword files are delivered:

File name	Content
Biorid-2_version_4.0.1_mm_ms_kg.key	dummy model, the name may vary depending on the unit system
BioRID-2_v4.0.X_all_units_load _curves_work.key	Work file used for pre-processing instead of license file. The file name might vary depending on the system of units
positioning_BioRid-2_4.X_mm_ms _kg.key	Parameterised file to: move whole dummy rotate upper legs move/rotate head relative to T1 vertebrae

**Table 2:** Files delivered.

The numbering scheme of the original model is shown in Table 3. On demand we deliver renumbered input decks, according to user specifications.

Component	Min ID	Max ID	Total number
Nodes	10000	296883	277341
Solids	310000	527414	217415
Beams	10000	158254	8198
Shells	160001	287668	127668
Discrete elements	10500	10501	2
Time history nodes	10000	10007	7
Time history beams	10000	150015	20
Materials	1001	1162	63
Sections	1001	1158	51
Hourglass	1001	1007	7
Load curves / tables	1000	1215	110
Parts	1	547	473
Joints	1000	1033	20
General joint stiffness	1000	1370	63
Local coordinate systems	1001	1139	122
Accelerometers	1001	1007	7
Set Parts	1001	1515	36
Contacts	1001	1015	12

**Table 3:** Model numbering scheme.

## 1. Keywords Used

The following control and database keywords are used:

*CONTROL_ACCURACY	*CONTROL_OUTPUT
*CONTROL_BULK_VISCOSITY	*CONTROL_SHELL
*CONTROL_CONTACT	*CONTROL_SOLID
*CONTROL_DYNAMIC_RELAXATION	*CONTROL_SOLUTION
*CONTROL_ENERGY	*CONTROL_TERMINATION
*CONTROL_HOURLASS	*CONTROL_TIMESTEP
*CONTROL_MPP_IO_NODUMP	*CONTROL_MPP_DECOMPOSITION_ARRANGE_PARTS

**Table 4:** Used Control cards.

The following database cards are defined:

*DATABASE_ABSTAT	*DATABASE_HISTORY_NODE
*DATABASE_BINARY_D3PLOT	*DATABASE_JNTFORC
*DATABASE_MATSUM	*DATABASE_NODOUT
*DATABASE_DEFORC	*DATABASE_RCFORC
*DATABASE_ELOUT	*DATABASE_SBTOUT
*DATABASE_EXTENT_BINARY	*DATABASE_RBDOUT
*DATABASE_GLSTAT	*DATABASE_SLEOUT
*DATABASE_HISTORY_BEAM	*DATABASE_BINARY_RUNRSF

**Table 5:** Used Database cards.

The following material models are used:

*MAT_ELASTIC	*MAT_NONLINEAR_ELASTIC _DISCRETE_BEAM_TITLE
*MAT_ELASTIC_TITLE	*MAT_NULL_TITLE
*MAT_FU_CHANG_FOAM_TITLE	*MAT_PLASTIC_KINEMATIC_TITLE
*MAT_LINEAR_ELASTIC_DISCRETE _BEAM	*MAT_RIGID_TITLE
*MAT_LINEAR_ELASTIC_DISCRETE _BEAM_TITLE	*MAT_SIMPLIFIED_RUBBER_TITLE
*MAT_LOW_DENSITY_FOAM_TITLE	*MAT_SPRING_NONLINEAR_ELASTIC
*MAT_MOONEY-RIVLIN_RUBBER_TITLE	*MAT_VISCOELASTIC_TITLE

**Table 6:** Used Material models.

The following other keywords are used:

*CONSTRAINED_EXTRA_NODES_NODE	*HOURLASS
*CONSTRAINED_JOINT_CYLINDRICAL_ID	*INITIAL_FOAM_REFERENCE _GEOMETRY
*CONSTRAINED_JOINT_REVOLUTE_ID	*INITIAL_STRESS_BEAM
*CONSTRAINED_JOINT_SPHERICAL_ID	*INTERFACE_SPRINGBACK_LSDYN A
*CONSTRAINED_JOINT_STIFFNESS	*KEYWORD

_GENERALIZED *CONSTRAINED_RIGID_BODIES *CONTACT_AUTOMATIC_NODES_TO_SURFACE_ID *CONTACT_AUTOMATIC_SINGLE_SURFACE_ID *CONTACT_FORCE_TRANSDUCER_PENALTY_ID *CONTACT_TIED_SHELL_EDGE_TO_SURFACE_ID_Beam_OFFSET *CONTACT_AUTOMATIC_BEAMS_TO_SURFACE_ID_MPP *CONTACT_GUIDED_CABLE *DAMPING_GLOBAL *DAMPING_RELATIVE *DAMPING_PART_STIFFNESS *DEFINE_COORDINATE_NODES *DEFINE_CURVE *DEFINE_TABLE *ELEMENT_BEAM *ELEMENT_DISCRETE *ELEMENT_SEATBELT_ACCELEROMETER *ELEMENT_SHELL *ELEMENT_SOLID *END	*LOAD_BODY_Z *NODE *PARAMETER *PARAMETER_EXPRESSION *PART *PART_CONTACT *SECTION_BEAM *SECTION_BEAM_TITLE *SECTION_DISCRETE *SECTION_SHELL *SECTION_SHELL_TITLE *SECTION_SOLID *SECTION_SOLID_TITIL *SET_NODE_LIST *SET_NODE_LIST_TITLE *SET_PART_LIST *SET_PART_LIST_TITLE *TITLE
--	---

**Table 7:** Other keywords used in the model.

After the \*END keyword the following Primer keywords are defined:

*ASSEMBLY *DUMMY_START *UNITS	*DUMMY_END *H_POINT
-------------------------------------	------------------------

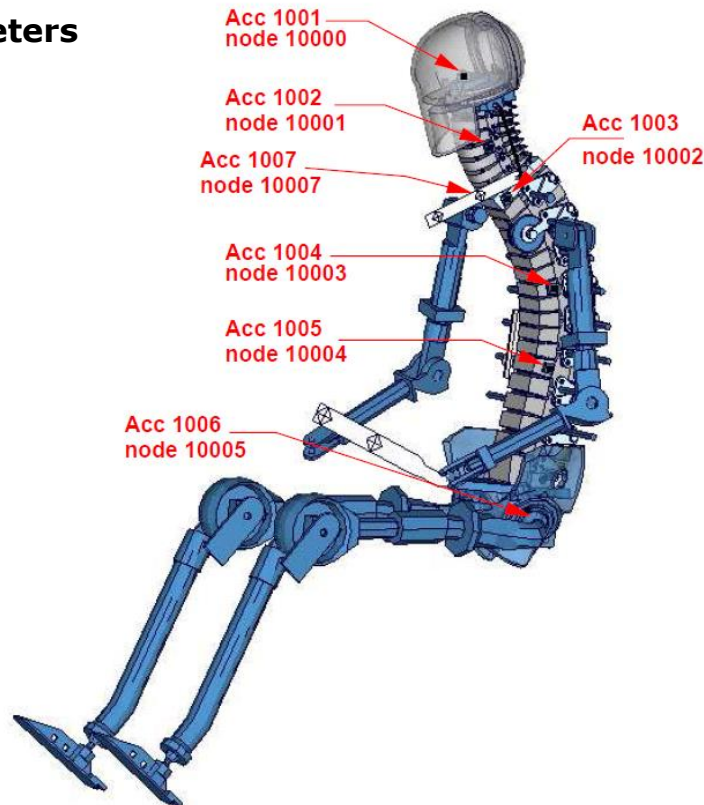
**Table 8:** Used Primer keywords.



## 2. Extraction of occupant injury criteria

To extract occupant injury criteria from the model, the following preparations have been made.

### 2.1 Accelerometers



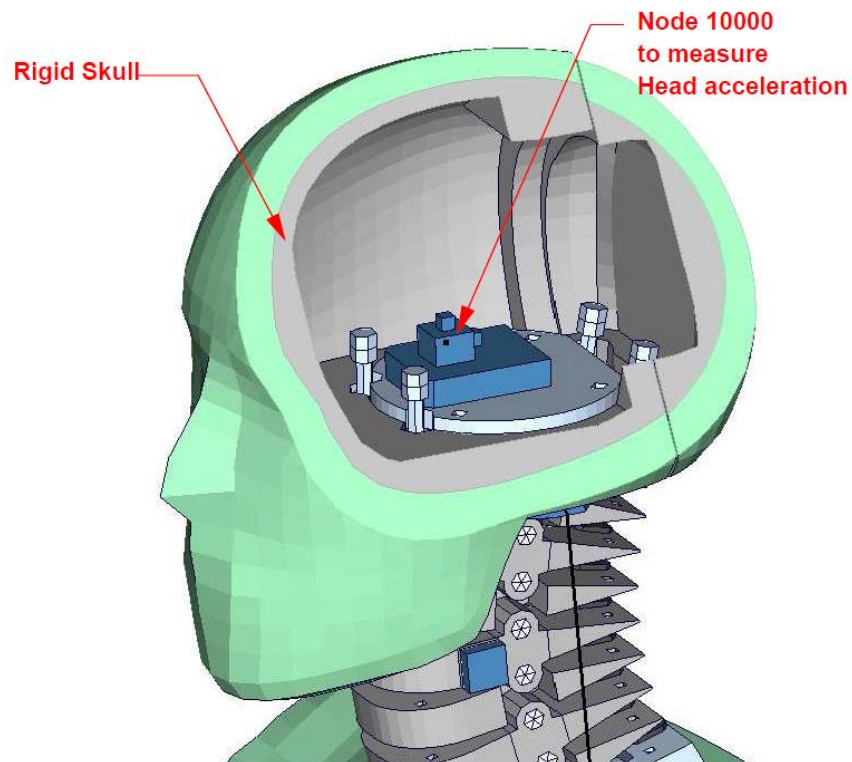
**Figure 1:** Location of accelerometers and history nodes.

The marked nodes, which are shown in Figure 1, are accelerometer nodes. The description of the accelerometer definitions for the local output is shown in next table.

Item	History Node-ID	Component
Head	10000	Local x/y/z-acceleration
Vertebra C4	10001	Local x/y/z-acceleration
Vertebra T1 left	10002	Local x/y/z-acceleration
Vertebra T1 right	10007	Local x/y/z-acceleration
Vertebra T8	10003	Local x/y/z-acceleration
Vertebra L1	10004	Local x/y/z-acceleration
Pelvis	10005	Local x/y/z-acceleration

**Table 9:** Accelerometer nodes.

## 2.2 Head acceleration



**Figure 2:** Location of head accelerometer node.

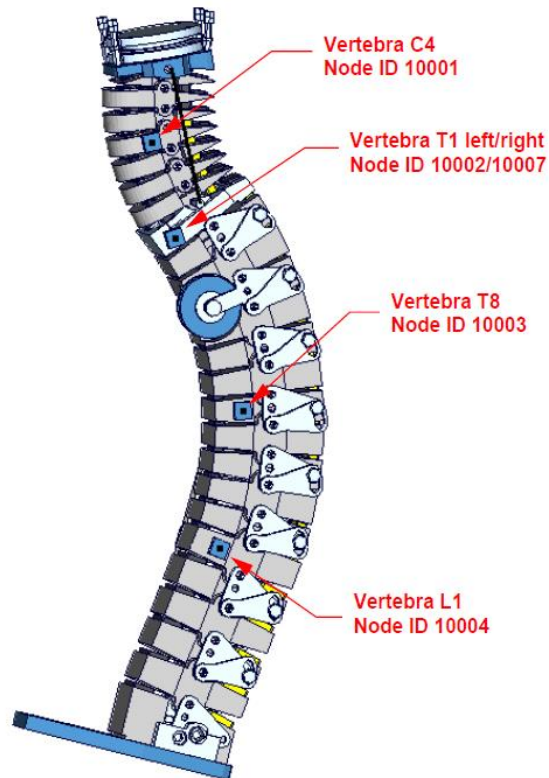
Figure 2 shows the head model; the Node 10000 is positioned at the centre of gravity of the head and an accelerometer is defined.

Item	Node-ID	Component
Head	10000	x-acceleration
Head	10000	y-acceleration
Head	10000	z-acceleration

**Table 10:** Head accelerometer node.

## 2.3 Spine accelerations

Four different accelerometers are defined on the spine of the BioRID. The accelerometers are shown in the Figure 3.

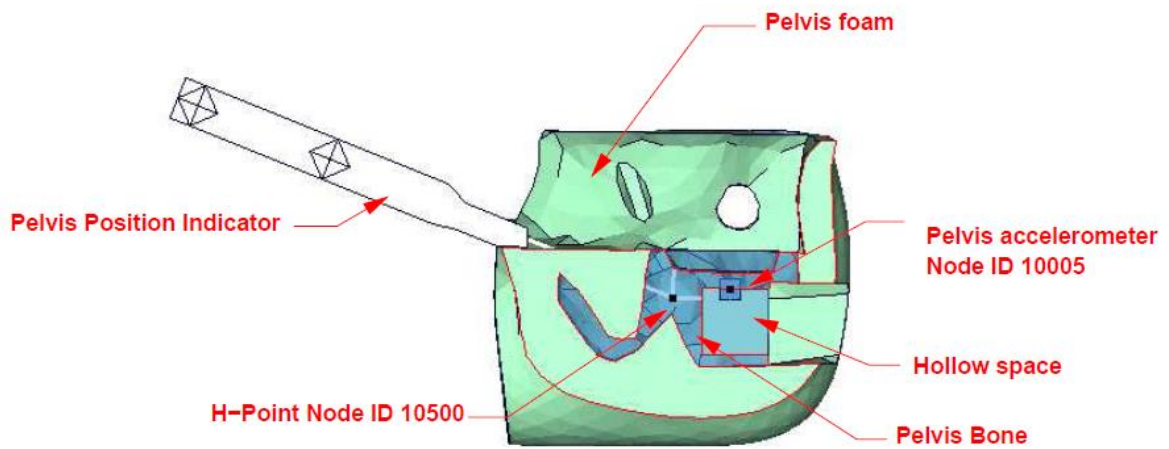


**Figure 3:** Node for extracting spine acceleration.

Item	Node-ID	Component
Vertebra C4	10001	x/y/z-acceleration
Vertebra T1 left	10002	x/y/z-acceleration
Vertebra T1 right	10007	x/y/z-acceleration
Vertebra T8	10003	x/y/z-acceleration
Vertebra L1	10004	x/y/z-acceleration

**Table 11:** Spine acceleration nodes.

## 2.4 Pelvis acceleration



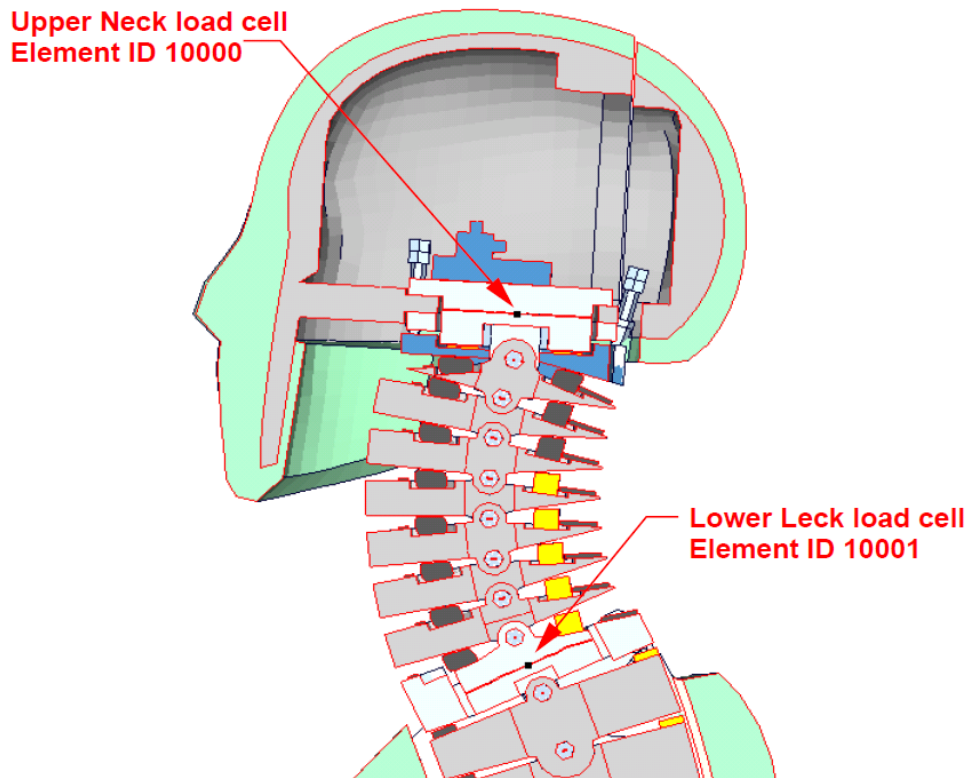
**Figure 4:** Location of node for extracting pelvis acceleration

Figure 4 shows a plane cut along the z-x plane. The accelerometer is mounted in the marked hollow space. Node 10005, on the top of the hollow space, is used as the accelerometer Node and an accelerometer is defined on it.

Item	Node-ID	Available components
Pelvis	10005	Local x/y/z-acceleration

**Table 12:** Pelvis accelerometer node.

## 2.5 Neck load cells



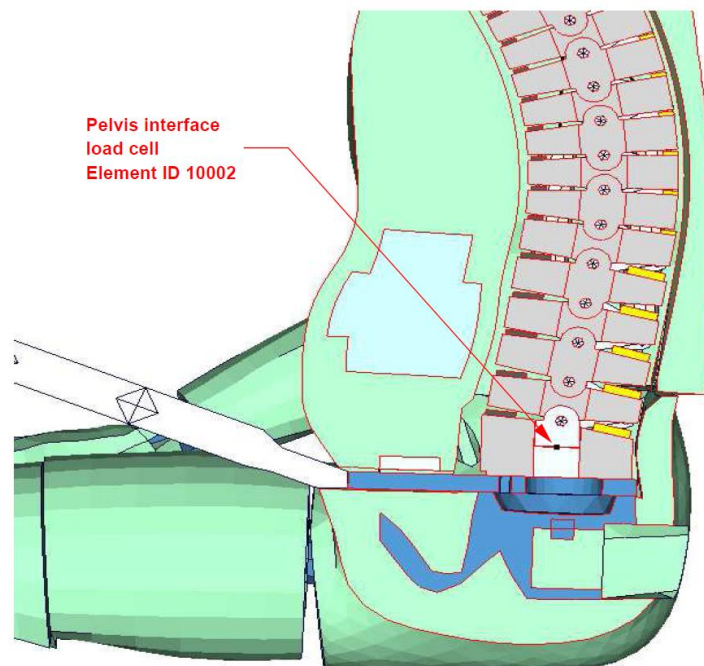
**Figure 5:** Model of lower and upper neck load cell

Figure 5 shows the location of the upper neck load cell and the lower neck load cell. Both are modelled as discrete beams. The table below gives details on the extraction of the loads.

Item	Beam-ID	Component in elout
Upper neck force x-direction (shear force)	10000	axial
Upper neck force z-direction (tension force)	10000	shear_t
Upper neck moment about y-direction (bending moment)	10000	moment_s
Lower neck force x-direction (shear force)	10001	axial
Lower neck force z-direction (tension force)	10001	shear_t
lower neck moment about y-direction (bending moment)	10001	moment_s

**Table 13:** Neck force and moment beams.

## 2.6 Pelvis interface load cell



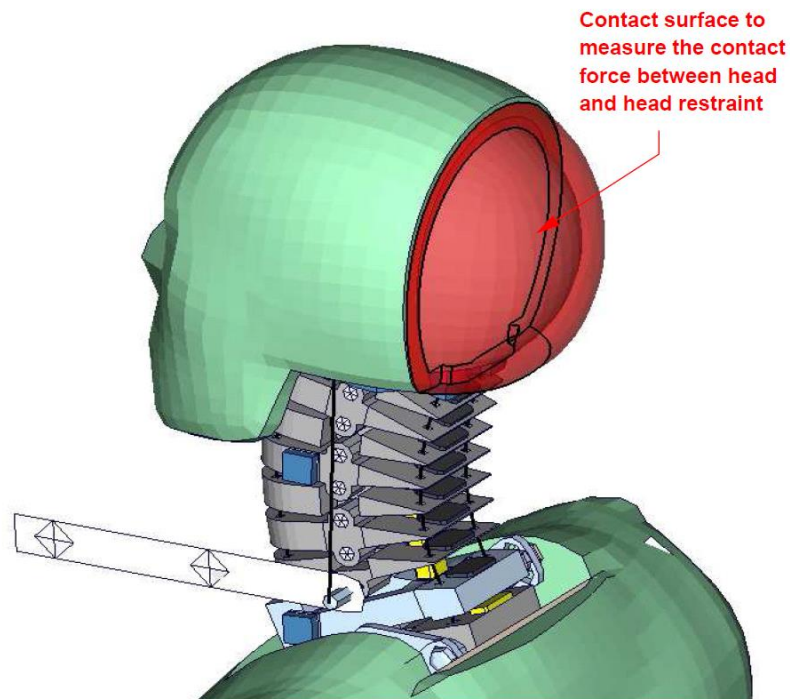
**Figure 6:** Pelvis interface load cell and discrete element ID.

Figure 6 shows the T12 area. The upper rigid beam is merged to spine and the lower rigid beam is merged to the upper lumbar spine adapter plate. Between the rigid beams a discrete beam is located to determine the T12- forces and moments. The local directions are shown in table below.

Item	Beam-ID	Component in elout
Pelvis force x-direction (shear force)	10002	axial
Pelvis force z-direction (tension force)	10002	shear_t
Pelvis moment y-direction (bending moment)	10002	moment_s

**Table 14:** Pelvis force and moment beam.

## 2.7 Force between head and head rest



**Figure 7:** Shells to extract force on the Head.

Figure 7 shows the contact shells at the back of the head. A \*CONTACT\_FORCE\_TRANSDUCER\_PENALTY\_ID is defined between this part and all other parts. This allows extracting the head contact forces from the RCFORC file. The table below gives details on the extraction of the force.

Item	Beam-ID	Label	Component
Force head to surroundings	1012	No Label	Resultant force

**Table 15:** Force on the back of head.

### 3. License file

The BioRID v4.0.1 is distributed with a license file which uses an expiry date. The license file is send to the user with the whole dummy package. For the BioRID there is a general license file for any unit system provided.

In the license file, all load curves are encrypted. There are parameters defined which can be used to offset the numbering of the load curves. The load curves can be scaled by using parameters which are encrypted in the normal BioRID input, but this may only be important for support issues. The names of the parameters refer to the table or load curve ID of each material. So if the values of the table ID 1002 are to be scaled then the parameter s1002 must be used.

The principle structure is as follows:

Input data of the BioRID-2 file:

```
*PARAMETER
$ Load Curve offset
I lcoff          0

$ Load Curve scale values
R sTABID        1.0
.
.
.
```

Input of the license file:

```
*PARAMETER_EXPRESSION
I brTABID      TABID + &lcoff
R eTABID       1.0 * &sTABID

*DEFINE_CURVE
&brTABID      0          1.0&eTABID          0.0          0.0
              <Values_x>      <Values_y>
.
.
.
```

The license file has to be included **in the dummy model main file AFTER the parameter block**. We recommend storing the license file of dummy models in a central place as read only. Furthermore the name of the license include should be simple like for instance Biorid\_v4.0\_license.asc.

With a symbolic link from the current license to this name it is possible to keep older input decks running without updating the input data of them.



As you may notice this description differs from the one in older model manuals. Since the release of LS-DYNA 971 R6.0 there was a little change in the parameter reading routine. If you locate like explained above the model will run in former LS-DYNA releases as well.

The expiry date, the owner of the license and the system of units are printed out in the d3hsp file of LS-DYNA. The name of the license file also includes the company name and the expiry date of the dummy.

For the work in a pre-processor, an additional file is delivered:

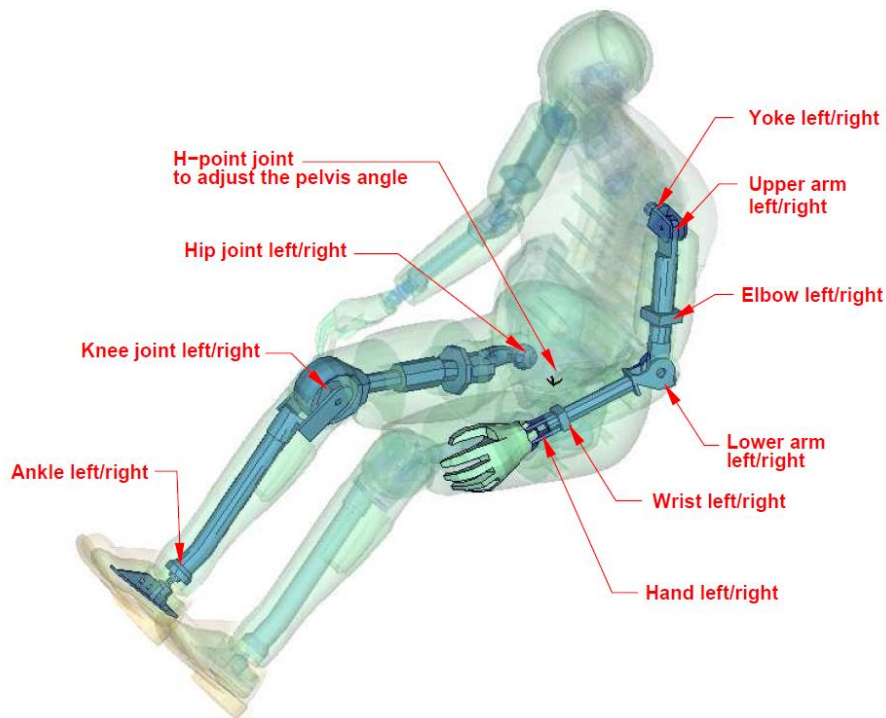
BioRID-2\_v4.0\_all\_units\_load\_curves\_work.key

This work file includes the same input as the encrypted license file. The only difference is the scaling of the load curves in the work file. The load curves are scaled randomly in a wrong range and they are much too soft to be used for a LS-DYNA simulation. But the file can be used to observe the quality and course of the material curves.

A LS-DYNA simulation in use of the work file will give wrong results and is very unstable.

## 4. Incorporating the dummy in seat models

### 4.1 Positioning, tree file



**Figure 8:** Cut through the model with joints.

The BioRID 2 model is delivered with a tree file for the Primer pre-processor (may work also for Hypermesh and ANSA, not verified by DYNAmore). This allows the user to position the dummy and adjust the parts according to their degree of freedom.

Figure 8 shows the connections of movable parts via tree file. All revolute joints are visualized by beams.

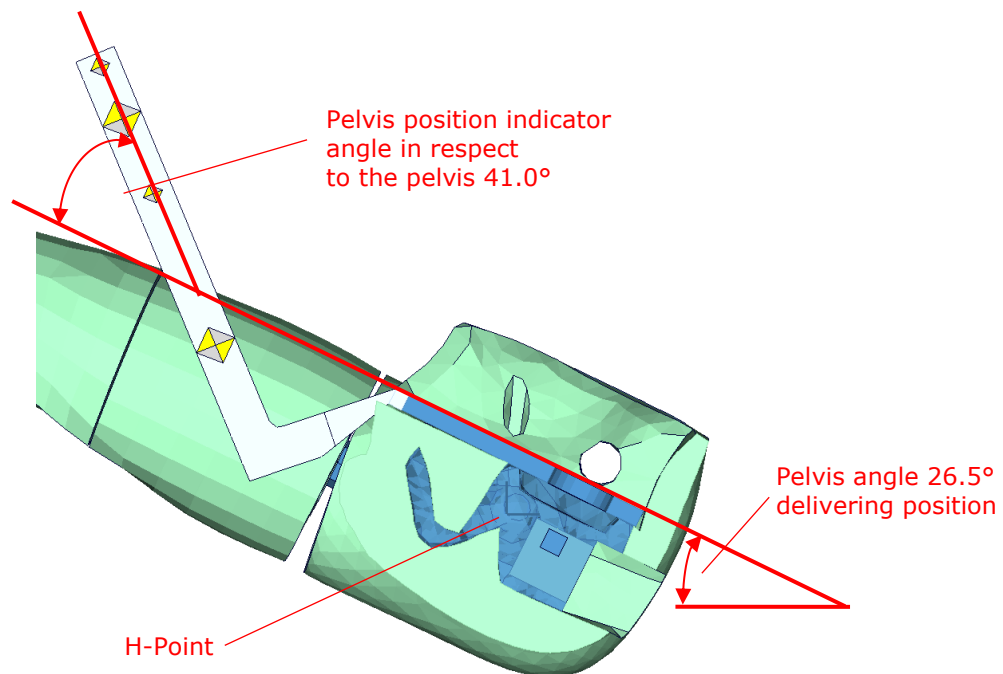
In the H-Point of the dummy model two coordinate systems are modeled. These coordinate systems are connected to each other by a spherical joint. One coordinate system is connected to global directions, e.g. only translations are possible, and rotations are disabled. The other one is connected to the dummy, so it is possible to measure quickly and easily the pelvis angle of the BioRID during the positioning simulation. These coordinate systems are also used to determine the initial pelvis angle with Primer.

Movable parts and revolute joints are:

- Hand, left and right (stop angle: +-50.0 degrees)
- Wrist, left and right (stop angle: +-90.0 degrees)
- Lower arm, left and right (stop angle: -90.0 and 1.0 degrees)
- Elbow, left and right (stop angle: +-90.0 degrees)

- Upper arm, left and right (stop angle: -1.0 and 60.0 degrees)
- Yoke, left and right (stop angle: -20.0 and 90.0 degrees)
- Foot, left and right about their ankle joints (stop angle: local x and z direction +-5.0 degrees local y direction -20.0 and 45.0 degrees)
- Lower leg, left and right about their knee joints (stop angle: -0.1 and 90.0 degrees)
- Upper leg, left and right about their local hip joints (local x- and z- coordinate) (x stop angle: -20.0 and 20.0 degrees)

If the upper legs are rotated at the hip joints about the given x stop angles, initial penetrations will occur. Rotations about the local z-coordinate will cause instantly penetrations. This can be observed in the hardware also.



**Figure 9:** Location of H-Point and initial pelvis angle.

Figure 9 shows the location of H-Point and the pelvis position indicator. More details are given in the "User's Guide BioRID-II; 2002, Denton ATD, Inc.". The following delivering position is used:

H-Point Node-ID	x-coordinate	y-coordinate	z-coordinate
10500	0.0	0.0	0.0
Pelvis angle	26.5 degrees		

**Table 16:** Delivering position of BioRID-2 model.

## 4.2 Positioning File

If the upper legs are rotated at the hip joints, initial penetrations would occur. This reaction is based on the hardware. In the hardware, the geometry is deformed if the position of the upper leg is changed with respect to the pelvis.

It is recommended to position the upper legs by a pre-simulation.

A special positioning-file <positioning\_BioRID-2\_v4.0.1\_mm\_ms\_kg.key> is delivered to do this pre-simulation. This file can also be used to move and rotate the head relative to the T1 vertebrae.

The positioning-file of BioRID-2 is very easy to use. At the top of this file you will find a set of parameters you have to set. These parameters are shown in the following table.

Parameter	Description
term	termination time
tmove	time to move parts
trans_x	x-translation of the whole dummy
trans_z	z-translation of the whole dummy
movhead	global x-translation head
rothead	local y rotation head
relhead	release time for head boundarys
lfemrx	left femur rotation about local x
rfemrx	right femur rotation about local x
lfemry	left femur rotation about local y
rfemry	right femur rotation about local y
lfemrz	left femur rotation about local z
rfemrz	right femur rotation about local z

**Table 17:** Positioning file parameters.

In case you do not want to translate or rotate an assembly use a very small value like 1.0E-20. Please do not use zero as value, because zero as scaling factor is default 1 in LS-DYNA. As second step you have to add your include-files necessary for positioning the dummy model.

Usually only seat and dummy models are used for the positioning procedure. Please define a \*CONTACT AUTOMATIC SURFACE TO SURFACE for the contact between the dummy and seat (environment). The BioRID-2 properties for this contact are prepared in the part set 1500.

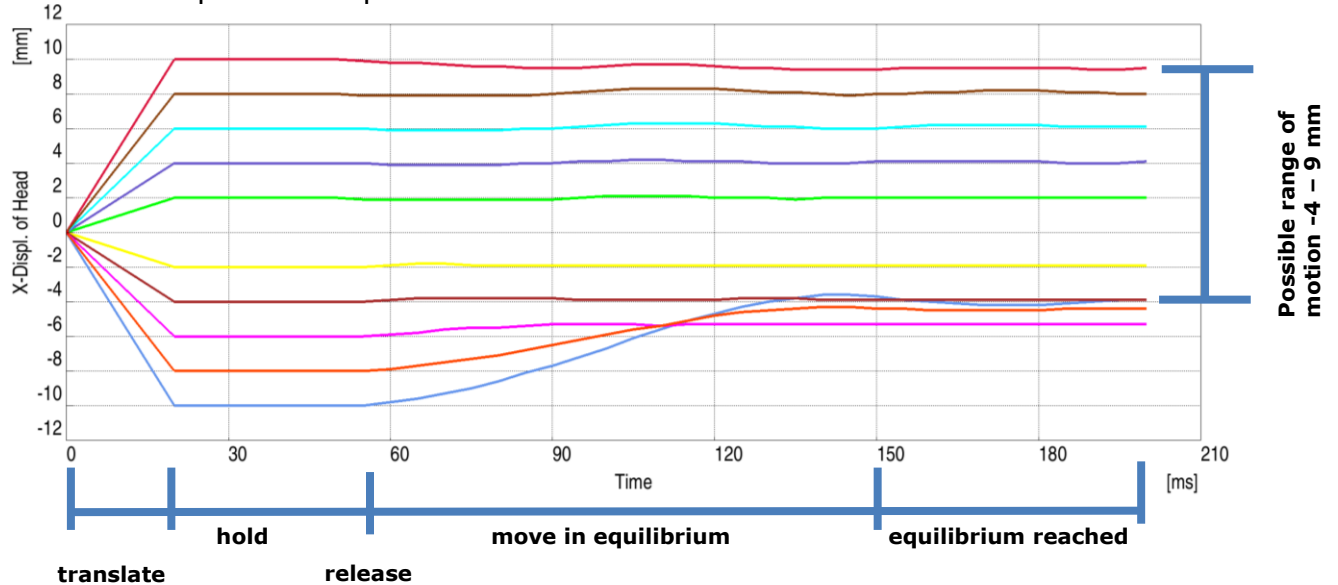
Since BioRID version v3.8 this file can also be used to adjust the Head position in respect to T1 vertebrae. In principle this can be done also meanwhile a pre-simulation where other limbs are moved.

To setup this simulation a value for the Parameter movhead must be specified. This value should not exceed the values where the Head will remain in position due to the cable friction. Please see chapter 4.3. If the values are chosen higher, the Head will not remain in position at the beginning of Whiplash simulation.

### 4.3 Head position adjustment

Since BioRID2 v3.8 it is possible to adjust the Head position in respect to the T1 vertebrae. This enhancement comes due to improvements of the cable friction in the BioRID2 v3.8.

To show the possible range of motion of the Head. Negative displacement is forward and positive displacement is backwards.



The curves show different phases of Head movement. At the end a possible range of motion is about 4mm forward and 9mm backwards.

**Translate phase:** Head is moved to a desired value in x-direction. In this position, it might be that the neck is not in equilibrium.

**Hold phase:** The Head is hold in position so that dynamic effects are decreased to a minimum. This phase can also be chosen smaller than 30ms (about 10ms should be enough).

**Release time:** The Head boundary are released at this time (see chapter 4.2 how Head is released). After this time the Head can move free in x-direction and y-rotation.

**Move in equilibrium:** In this phase the Head moves on his own to an equilibrium between Bumper forces, cable friction and Spring forces.

**Equilibrium reached:** The equilibrium in the neck is reached and there is no more movement in the neck.

The head is positioned different in respect to T1 vertebrae. This state can be used then as new position of the Head, but it is necessary after this simulation to update the spring forces to the new values  $ps_{front}$  and  $ps_{rear}$  of the springs 10500 and 10501 to the new values.

It is also necessary after this simulation, to repair the seatbelt slip ring definitions in the BioRID2 model. This can be done like described in chapter 4.4.

#### 4.4 Repairing Seatbelt Elements

Since BioRID2 v4.0 there is a new cable model system which is without Seatbelt Elements. The Repairing Seatbelt Elements Script is not necessary anymore and will be not included in the delivery data.

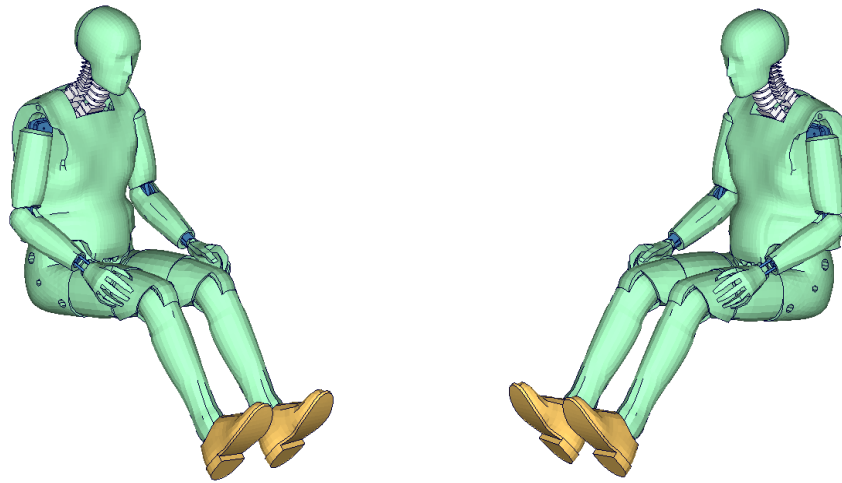
#### 4.5 Common Workflow for positioning under gravity load

- Use the BioRID-2 model which prepositioned in your favourite pre-processing tool. Position it as far as possible into an undeformed seat model without penetrating it. This should be the starting point of your seating simulation.
- Run this simulation with gravity and little global damping about 1 to 1.2 seconds. At the end of this simulation the dummy model should rest in equilibrium and the kinetic energy should be around zero.
- Unless the dummy model does not reach the zero angle head position you have conduct a separate position correction by a simulation.
- If the back set of the BioRID head is much to large as desired, it is possible to rerun the positioning simulation again and push the BioRID at the T1 load cell backwards by using \*LOAD\_NODE keyword. The load should be only used for a short time phase when the model has closed contact to the seat. At the end of the simulation all external loads should be released.
- Now – when dummy and seat model are in the desired position – assign the deformed geometry to your origin input decks.
- In a further step read out the resultant forces of the discrete springs (ID 10500 and 10501) at the end of the seating simulation. Transfer the amount of the forces to the model input. We provided the two parameters (psfront and psrear) for setting these values.
- Start your whiplash simulation run.

#### 4.6 Numbering

- Nodes in the range of 10.000 to 11.500 are used for the definition of joints, accelerometers, etc.
- Nodes with node IDs above 11.500 are used only in \*NODE and \*ELEMENT cards
- Elements in the range of 10.000 to 11.500 are used for the definition of history, discrete elements, slip ring elements, etc.
- Elements with IDs above 11.500 are used only in \*ELEMENT cards.

## 4.7 Contact definition



**Figure 10:** Parts used in contact definition.

- For the contact of the dummy model with the vehicle and the seat, an automatic node to surface or automatic surface to surface contact is proposed.
- The usage of a single surface contact is not recommended. This might interfere with the contact definitions of the dummy model itself.
- Table 18 depicts parts proposed to be used in contact definition of dummy with vehicle and seat:

Item	Part-ID	Item	Part-ID
head contact shells front	5	upper leg right skin	366
head contact shells rear	6	knee right skin	370
vertebra null shells rear	218	foot null shells	378
vertebra null shells	221	lower leg right skin	379
vertebra null shells	222	shoe right	381
contact shell Teflon plate on torso	277	upper arm left skin	408
contact shell Teflon plate	278	lower arm left skin	409
torso outer contact shells	292	hand left skin	410
pelvis outer skin	304	null shells bones arm left	411
upper leg left skin	326	upper arm right skin	458
knee left skin	330	lower arm right skin	459
foot null shells	338	hand right skin	460
lower leg left skin	339	null shells bones arm right	461
shoe left	341	null shells on gaps of lower arms	490

**Table 18:** Properties for external contact.

#### 4.8 Additional remarks

- The modification of the \*CONTROL cards of the dummy file may have an influence on the performance and robustness of the model. Therefore the \*CONTROL cards of the dummy model are proposed for simulations with the seat model as well.
- In case modifications in the control cards are needed for the seat model, we offer to run a subset of the validation runs with the modified control cards to evaluate the influence. Please contact your local support for details.
- All nodes have a connection to an element except the third beam nodes of all beam elements.
- The model is free of initial penetrations.
- The Version 4.0.1 of the BioRID provides parameters to scale the friction of the joint off all limbs. As default a 1 g adjustment of the joints is included. The user is now able to increase or decrease the friction values of the joints. The scale factors are used for the left and right hand side assemblies. So it is not possible to scale left and right assembly different.

Parameter name	Joint
sfankl	Scale factor ankles
sfknee	Scale factor knees
sfuleg	Scale factor upper legs
sfyoke	Scale factor yokes
sfuarm	Scale factor upper arms
sflarm	Scale factor lower arm
sfelbo	Scale factor elbow
sfhawr	Scale factor wrist

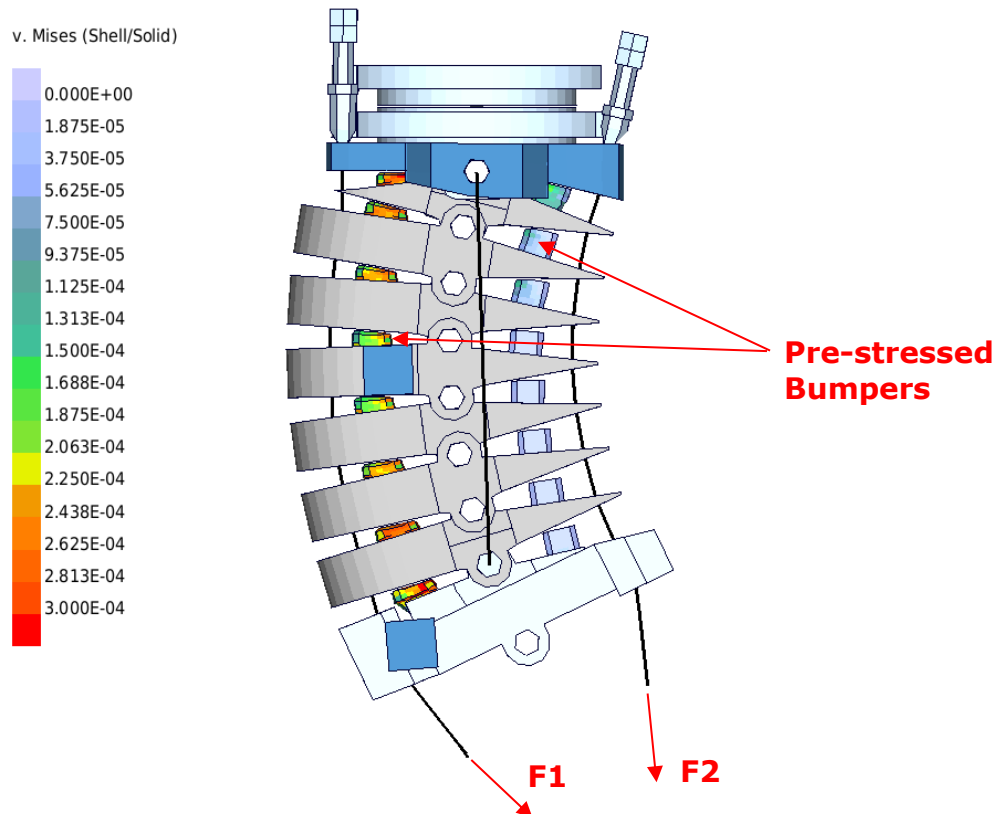
**Table 19:** Parameters to scale joint friction.

- One more additional parameter is put into the model. It is used to switch off the dynamic relaxation of the model. swrelax=1 means on and swrelax=0 means off.
- The validation of the model is done based on all tests which are shown in the manual. Validation target is to get a model with physical definitions as close as possible to the test results.  
It might be possible that there are loading conditions which are not observed until now in the validations test and the validation does not fit to these new not known conditions. Due to this the user is responsible for his own results.



## 4.9 Prestressed components of the BioRID

The Spine of the BioRID-II model is fully prestressed. In the delivery position the bumpers and the muscle substitute springs are fully prestressed. The thoracic and lumbar spine are in a stress free position.



**Figure 11:** Pre-stress in the BioRID2 model

Figure 11 shows the prestressed components of the neck. The neck is adjusted as prescribed in the "BioRID-II User's Guide Denton ATD, Inc., 2002". The delivery position of the thoracic and lumbar spine is stress free. The pre-stresses are generated as follows:

- The initial stress in the bumpers is prescribed by use of the keyword \*INITIAL\_FOAM\_REFERENCE\_GEOMETRY.
- The muscle substitute springs are prestressed by an offset in the load curves. The Parameter for Prestress of cable springs: &psfront and &psrear.
- The torsional beams of the thoracic and lumbar spine are automatically prestressed after a positioning simulation. This is done by the use of relative rotation of the coordinate systems, which are referenced in the joint stiffness cards

## 4.10 Release notes

The following major modifications are made:

### 4.10.1 Release notes from v4.0 to v4.0.1

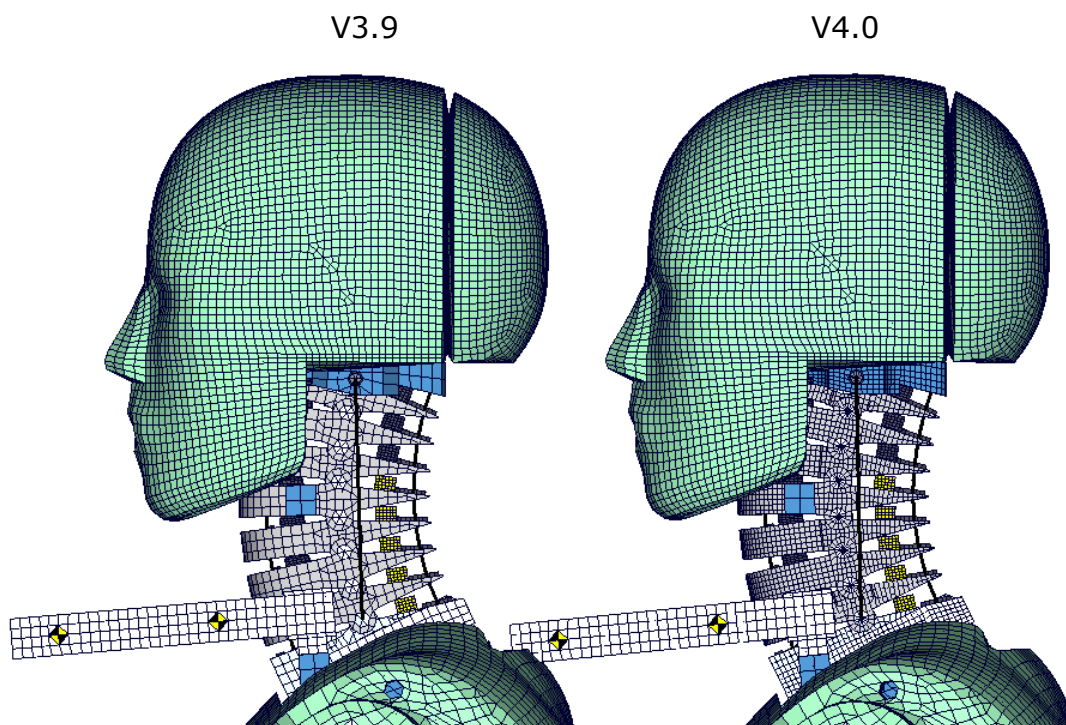
- Accelerometer \*ELEMENT\_SEATBELT\_ACCELEROMETER update

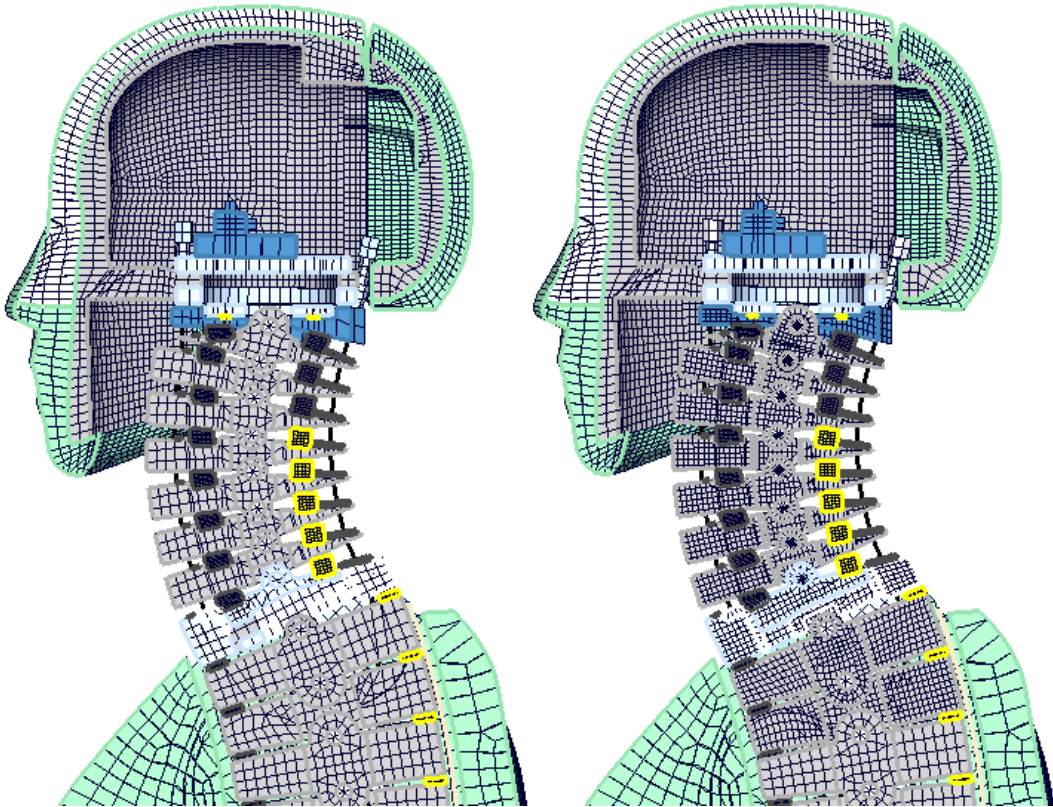
In order to match with the accelerometer hardware better the \*ELEMENT\_SEATBELT\_ACCELEROMETER Parameter IGRAV is changed from 0 to 1. This may lead to the initial acceleration is not zero in whiplash simulation after pre-simulation (Dummy-seat positioning). In that case the acceleration output should be offset to make sure that the initial acceleration is the same as the hardware output.

- \*CONTACT\_GUIDED\_CABLE\_SET\_ID instead of \*CONTACT\_GUIDED\_CABLE\_ID

### 4.10.2 Release notes from v3.9 to v4.0

- Geo Update: New finer mesh from C1 to T1





- Jacket is adjusted to suit the new neck model.
- Cable model method: 1D beam elements instead of seatbelt elements to simulate the cable, \*CONTACT\_GUIDED\_CABLE key word is used to guide 1D beam elements.



The real cable thickness can be defined in 1D beam elements cable system. In version 4.0 the contact details can be simulated, seatbelt elements cable system doesn't have this advantage behavior.

**Repairing Seatbelt Elements after pre-simulation is not necessary anymore.**

- Contact between neck bumper and cervical vertebrae: Soft 2 contact type is used to improve contact behavior.
- Parameters which defined by \*PARAMETER\_EXPRESSION are unencrypted.
- Development time step is adjusted to 0.7 microseconds.
- There are some contact, material updates and debugs in the model.

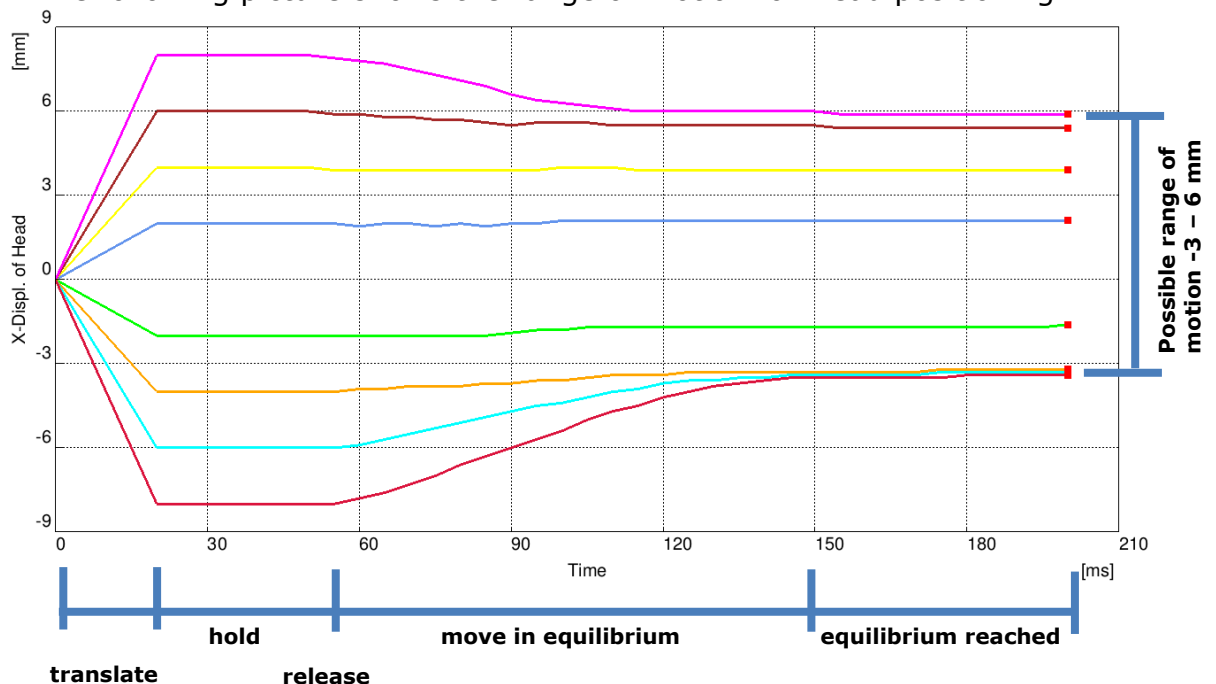
**4.10.3 Release notes from v3.8 to v3.9**

- Encountered oscillations of the history signals have been minimized. Therefor the model is upgraded by integration of specific damping and some material improvements. Also the behavior of the flesh of the BioRID during load is changed.

**4.10.4 Release notes from v3.6 to v3.8**

- Cable friction is improved to get different Head positions in respect to T1 vertebrae. The Head can now be positions in a range of 3mm forward and 6mm backwards and it will remain in this position.

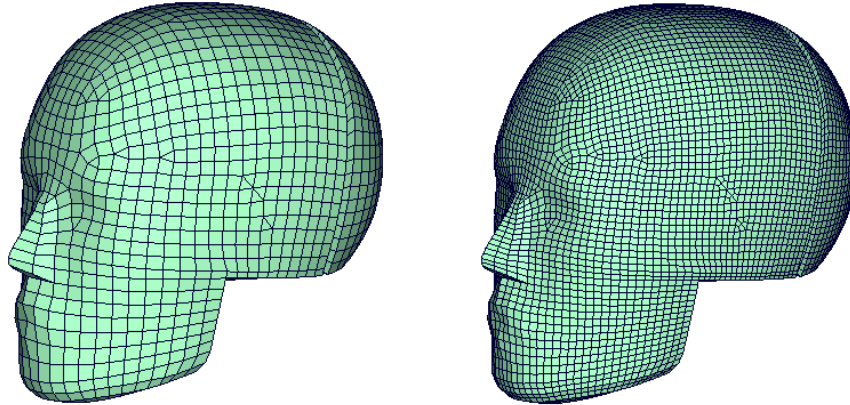
The following picture shows the range of motion for Head positioning:



A more detailed description how to position Head in respect to T1 you can

find in chapter 4.3.

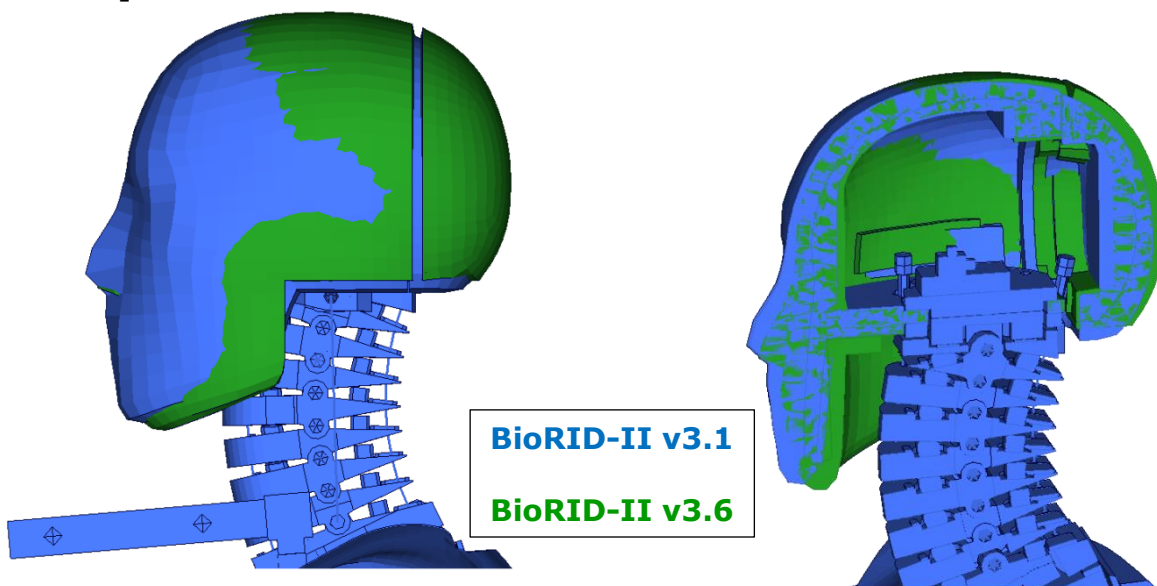
- The head is meshed more fine and the chin area is modelled more in detail to capture contact situations between head and neck more accurate. The flesh of the chin area is now separated from the bone.



**Figure 12:** Head mesh of v3.5 (left hand side) and v3.8 (right hand side)

#### 4.10.5 Release notes from v3.1 to v3.6

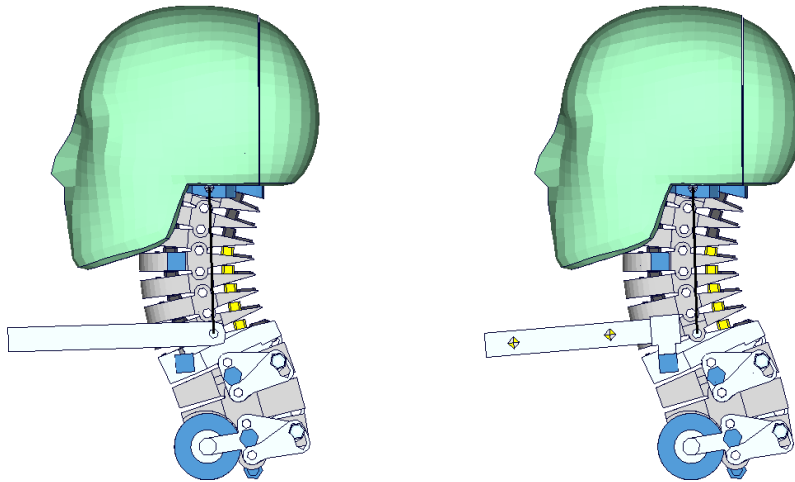
- Head geometry is updated:
  - Customer observations found that the BioRID-II Head is in nearly all cases positioned too much forward compared to test data.
  - New CAD data of an H350 Dummy was used to check the geometry (is the same as for BioRID-II) of the Head.
  - Differences are found and included in the v3.6 of the BioRID-II.
  - At the back of the Head the new Head is about 5mm more backwards.
  - Centre of gravity of Head is still at the same position.
  - The back set of the BioRID-II v3.6 in a seat model must be about 5mm smaller than with the older BioRID-II models.
  -



**Figure 13:** Head geometry of BioRID-II v3.1 compared to v3.6

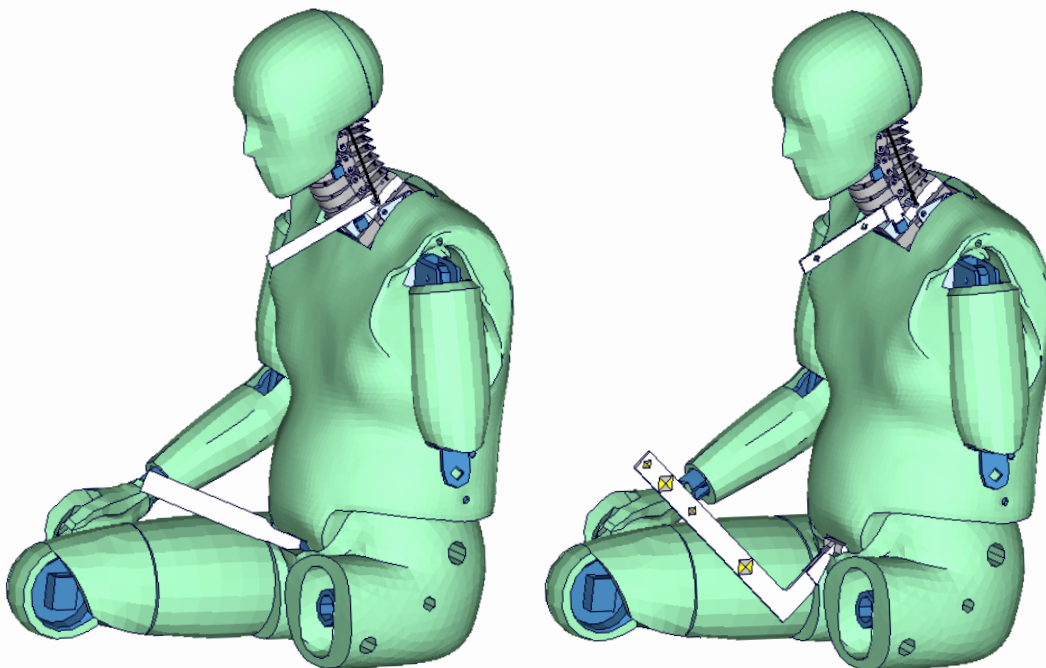
#### 4.10.6 Release notes from v3.0 to v3.1

- The positioning indicator of T1 is updated on the hardware build level G



**Figure 14:** T1 position indicator of version v3.0 and v3.1

- The positioning indicator of pelvis is updated on the hardware build level G

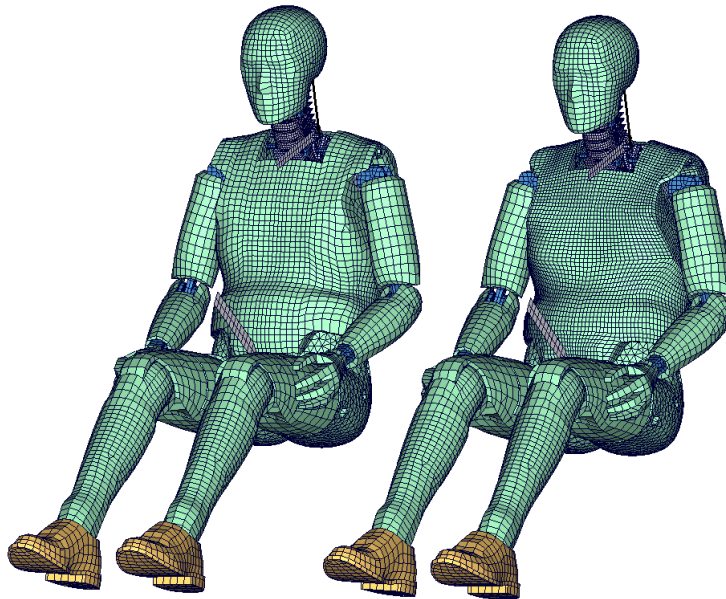


**Figure 15:** pelvis position indicator of v3.0 and v3.1 of BioRID-2

- For both systems of units is only one license file needed now. The system of units is scaled in the right range by parameters in the unencrypted model

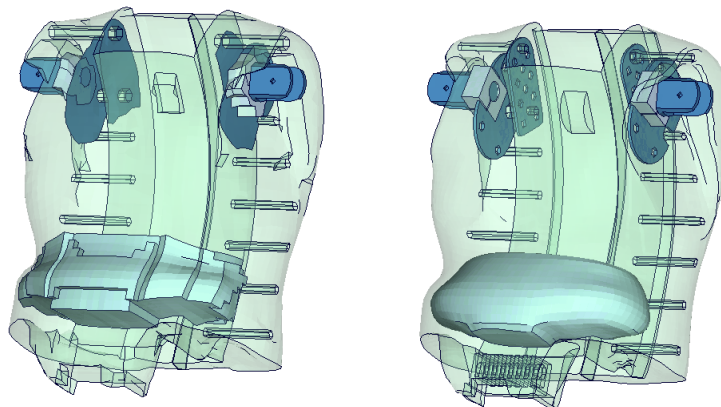
#### 4.10.7 Release notes from v2.5 to v3.0

- The complete torso flesh assembly is discretized by a new mesh. The mesh now is finer in order to capture geometric details in a more accurate way.



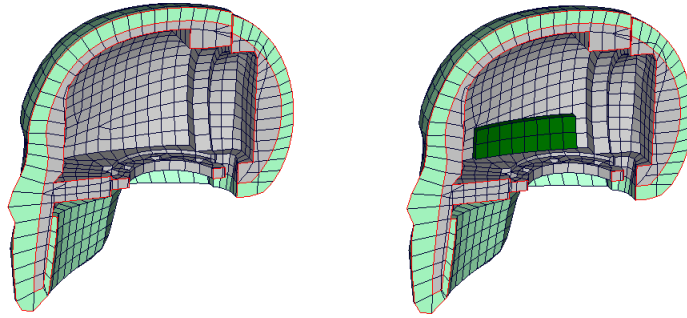
**Figure 16:** new torso mesh

- Internal parts of the torso mesh are remeshed as well. The connection plates of the arm joints now consist out of solid elements. As shown below the geometry of water cavity is now considerably more accurate.



**Figure 17:** new mesh of the water cavity

- The mass distribution of the head assembly is adjusted by introducing two additional weight parts



**Figure 18:** new skull with additional weight parts

- The distance between the H-Point and the H-Point mounting hole is adjusted to a z-height of 2.57" (65.28mm) to fit the specifications of the hardware manual.
- There are several minor validation tweaks in the spine and torso to fit the guided sled certification test.
- The v3.0 model provides parameter for adjusting joint friction of the lower and upper extremities
- Furthermore there is a parameter for switching on/off the dynamic relaxation
- Parameters for defining pretension of the front and rear spine springs are defined

#### **4.10.8 Release notes from v2.0 to v2.5**

- The pelvis foam stiffness is adjusted to the new material behaviour of the Pelvis foam. The new material is included by Denton since the BioRID build level G.
- Two Pelvis materials are present in the BioRID v2.5 model. As default we have the MID 1118 as the latest pelvis foam material, which is tested in the pelvis component test. As a variation one can use the pelvis material of the BioRID-II build level G (MID 1119) which was also used in the BioRID-II v2.0 model. The same is done for the rubber skin of the pelvis. The new default material is MID 1120 and the older material is MID 1121. To switch to the old pelvis material please use for the pelvis foam (PID 301) material, the material MID 1119 instead of MID 1118 and for the pelvis skin (PIDs 302, 303, 304, 305), the material MID 1121 instead of 1120.
- The pelvis rotation is validated to new tests with the BioRID in a sports car seat. This is done by adjusting the joint stiffness of the hip joints.



- The joint stiffness of the feet is also adjusted to the new tests.
- The prestress option for the torso and the upper legs by using initial foam reference geometry is switched on.
- The script to repair seatbelt elements after pre-simulations is enhanced to get fewer errors. The new script can be used for both BioRID v2.0 and BioRID v2.5 models.

#### 4.10.9 Release notes from v1.5 to v2.0

- The rubber bumpers in the spine now use the MAT\_181 (\*MAT\_SIMPLIFIED\_RUBBER) in conjunction with the \*INITIAL\_FOAM\_REFERENCE\_GEOMETRY. This is the reason, that the BioRID can only be used with the following LS-DYNA releases:
  - For 970 you have to use:  
970.6763.2.361 from the 04/25/2006 or newer.
  - For 971 R2 (R2 means all 971.7600 versions):  
971.7600.2.525 from 07/10/2006 or newer
  - For 971 R3 (R3 means all 971 versions > 971.7600):  
971.9080 or newer than 07/09/2006.

If another LS-DYNA version is used, the BioRID model will not terminate with an error but the results of the simulation will be wrong. Please contact your local LS-DYNA distributor to get the right LS-DYNA version.

- At the back of the dummy, the torso flesh is opened.
- The Teflon plate in the back of the torso flesh is modeled on contact.
- It is only plugged in beadings on both sides in the torso flesh.
- Friction tests, between different parts in the dummy model, initiated by the FAT working group are included.
- The geometry of the T1 vertebra is modified. It is now more accurate and the lateral strain of the bumpers on T1 is now hindered more realistically.
- A second accelerometer is defined on the T1 vertebra on the right hand side.
- The BioRID2 calibration test is now fulfilled.
- The gaps of the upper arms are closed by the use of contact shells to get a more stable contact to the seat.
- A small Script is offered which can be used to repair the Seatbelt Elements after a full deformed positioning simulation.

## **5. Future work**

- Furthermore we are working on better neck and pelvis performance.
- In parallel we are working on using LS-DYNA implicit to position the BioRID-II more efficient.

## 6. Material tests

Material tests on all major foams and rubber like materials have been performed. The specimens were taken from blocks provided by Denton COE in Heidelberg. The blocks are depicted below.



**Figure 19:** Material samples for material tests

The following materials were tested:

- Pelvis foam
- Upper arm foam
- Upper leg foam
- Lower leg foam
- Yellow urethane bumper
- Black urethane bumper
- Vinyl (Skin)
- Silicone (Thorax flesh)

The tests were adapted to derive material data for \*MAT\_FU\_CHANG\_FOAM and \*MAT\_SIMPLIFIED\_RUBBER. Hence, the emphasis was on static and dynamic tension and compression tests. For the rubber like materials, the compression tests were also performed with a lateral obstructed expansion. The used strain rates were:

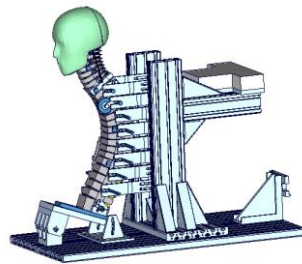
Test	Type	Strain rate	Lateral expansion
1	Tension	0.001 1/s (static)	free
2	Tension	0.1 1/s	free
3	Tension	10 1/s	free
4	Tension	100 1/s	free
5	Tension	500 1/s	free
6	Compression	0.001 1/s (static)	obstructed
7	Compression	0.001 1/s (static)	free
8	Compression	0.1 1/s	free
9	Compression	10 1/s	free
10	Compression	100 1/s	free
11	Compression	500 1/s	free

## 7. Performance

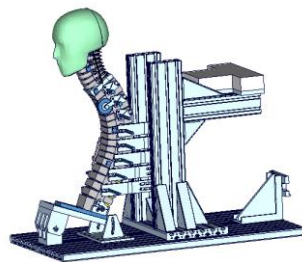
### 7.1 Sled test with spine only

For validation of the Spine we use three different sled tests which are carried out only with the spine of the BioRID.

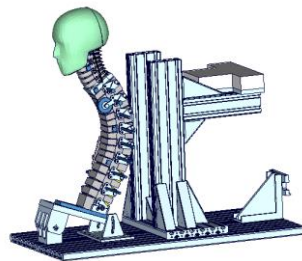
The sled is the same in all cases, but the connection of the spine to the sled is different in all three cases.



**(a) Fixed up to T1**



**(b) Fixed up to T8**



**(c) Fixed pelvis plate (L6)**

**Figure 20:** Spine component tests

Figure 20 shows the three connection cases. All cases are loaded with a 6g triangular pulse, which is shown for each case on page 3 of the results.

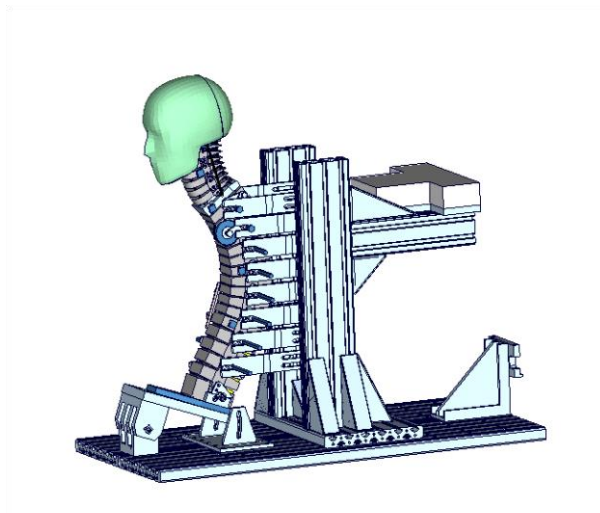
- In the first case, the spine is connected from the pelvis plate up to the T1 vertebra on the sled.
- In the second case, the spine is connected from the pelvis plate up to the T8 vertebra on the sled.
- In the third case, the spine is only connected with the pelvis plate (L6 vertebra) to the sled.

For each of these cases we again had two modifications of the spine. They are:

- the complete spine with rotational damper and with muscle substitute springs
- spine without rotational damper and with muscle substitute springs

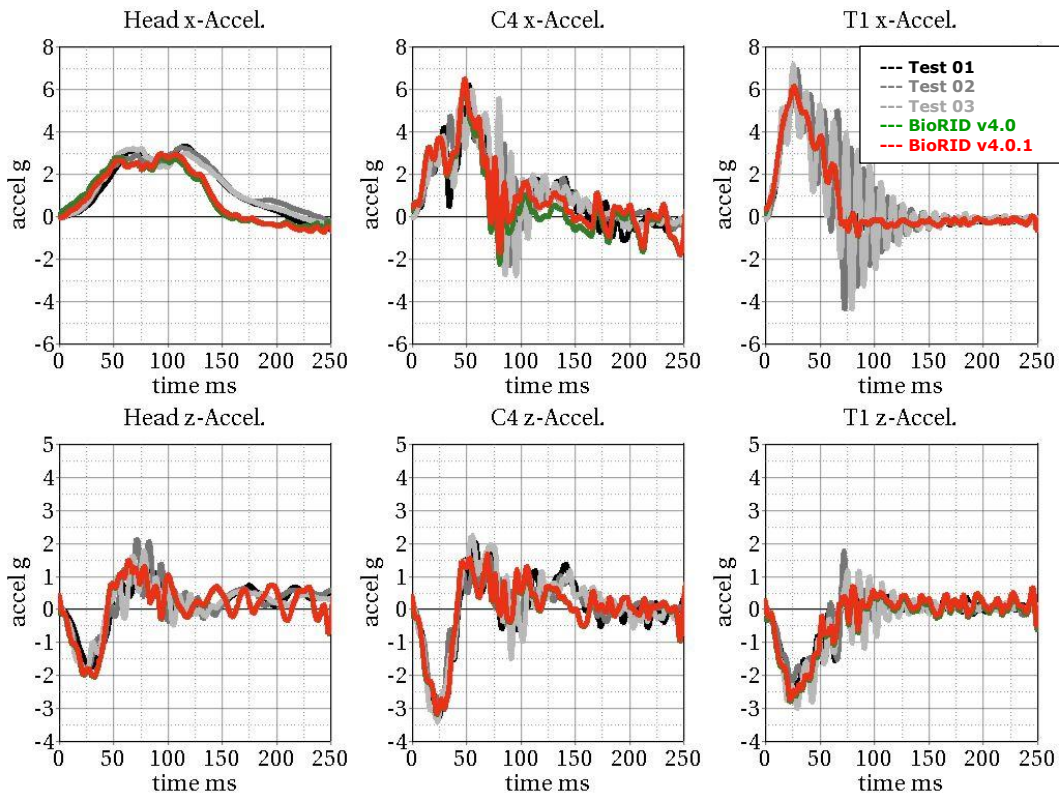
All the following results use the same colouring scheme. The black and grey curves are the test data, the green curves show the results of BioRID-II v3.9 and the red curves show the results of the BioRID-II v4.0.

### 7.1.1 Results of spine fixed up to T1

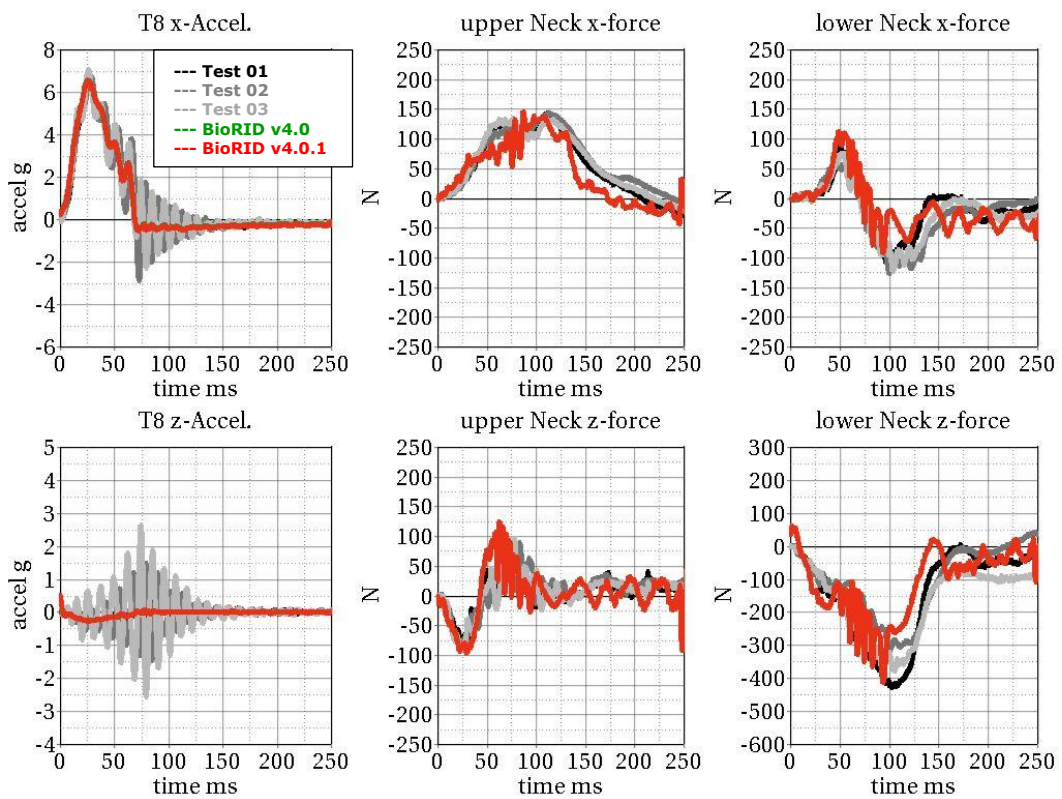


**Figure 21:** Spine fixed up to T1.

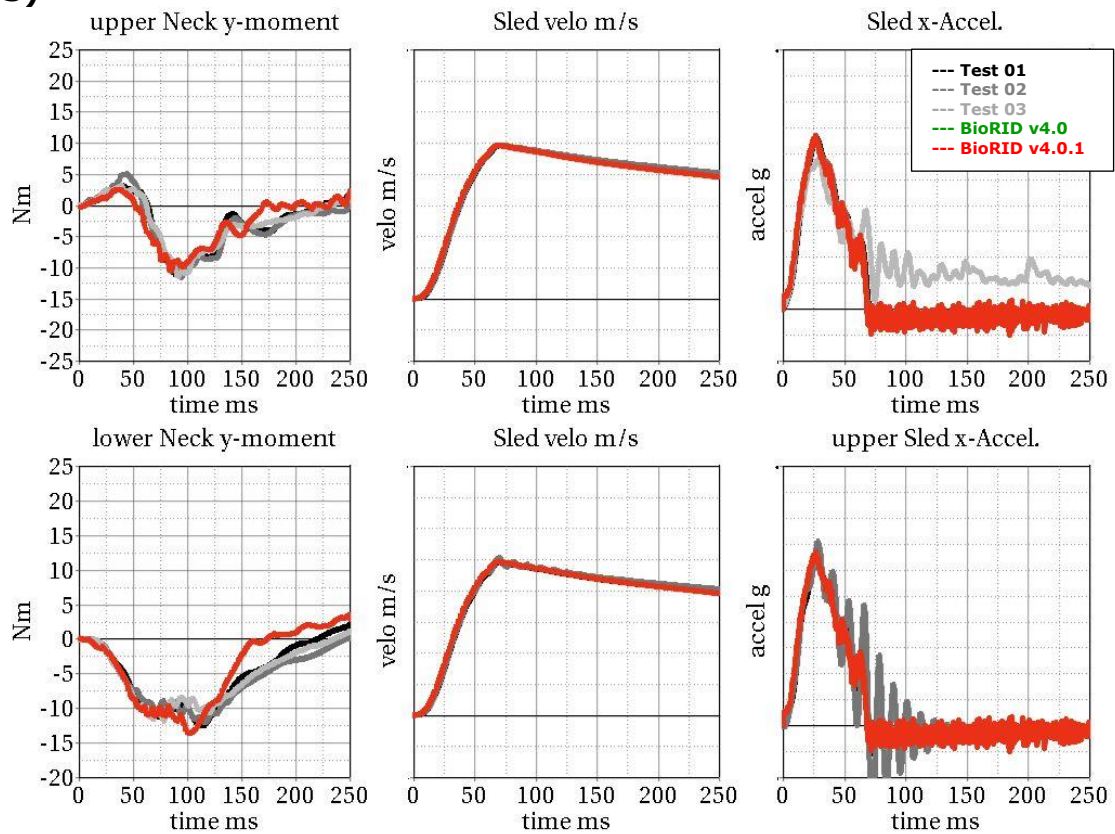
**Spine fixed up to T1 with damper/with muscle substitute springs (Page 1)**



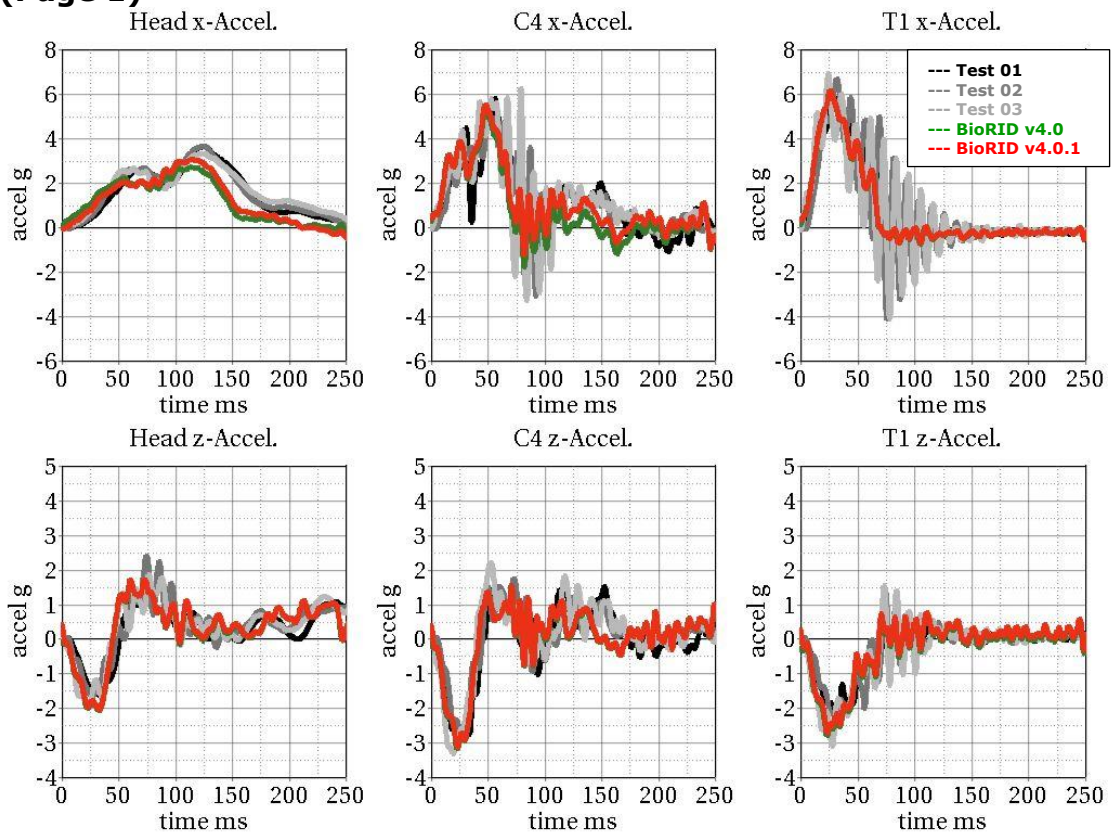
**Spine fixed up to T1 with damper/with muscle substitute springs (Page 2)**



**Spine fixed up to T1 with damper/with muscle substitute springs (Page 3)**

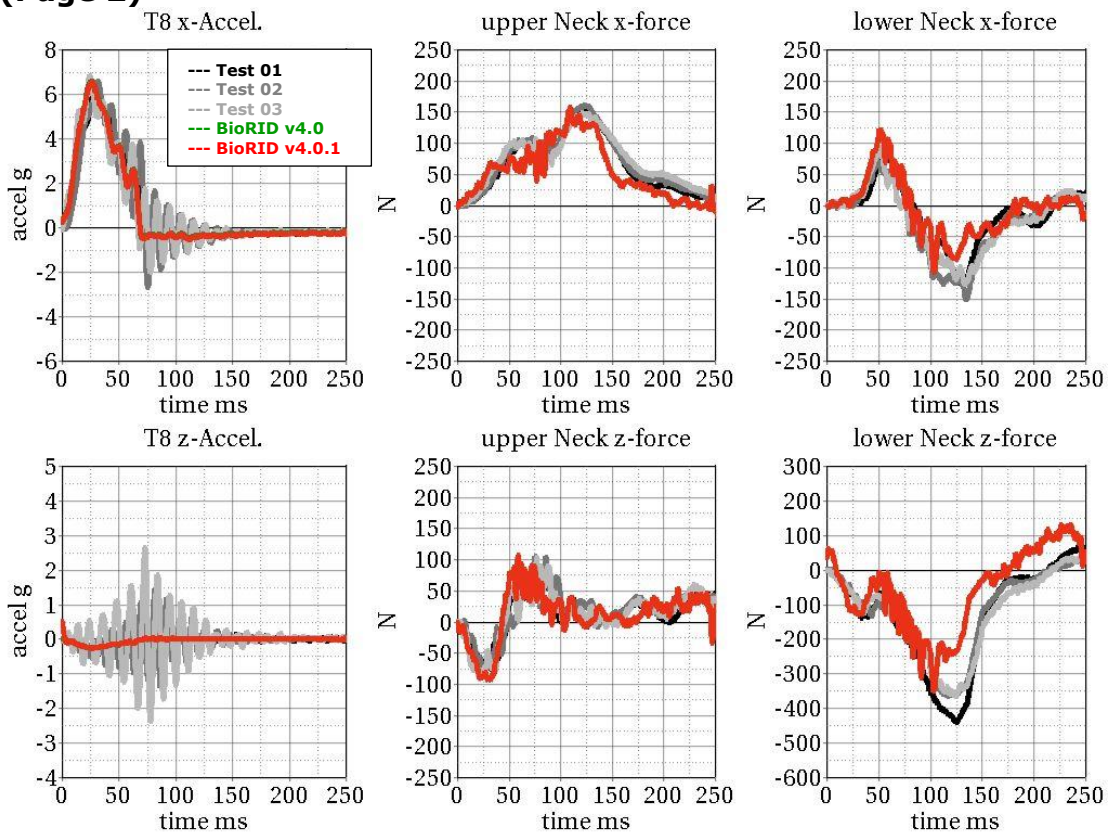


**Spine fixed up to T1 without damper/with muscle substitute springs (Page 1)**

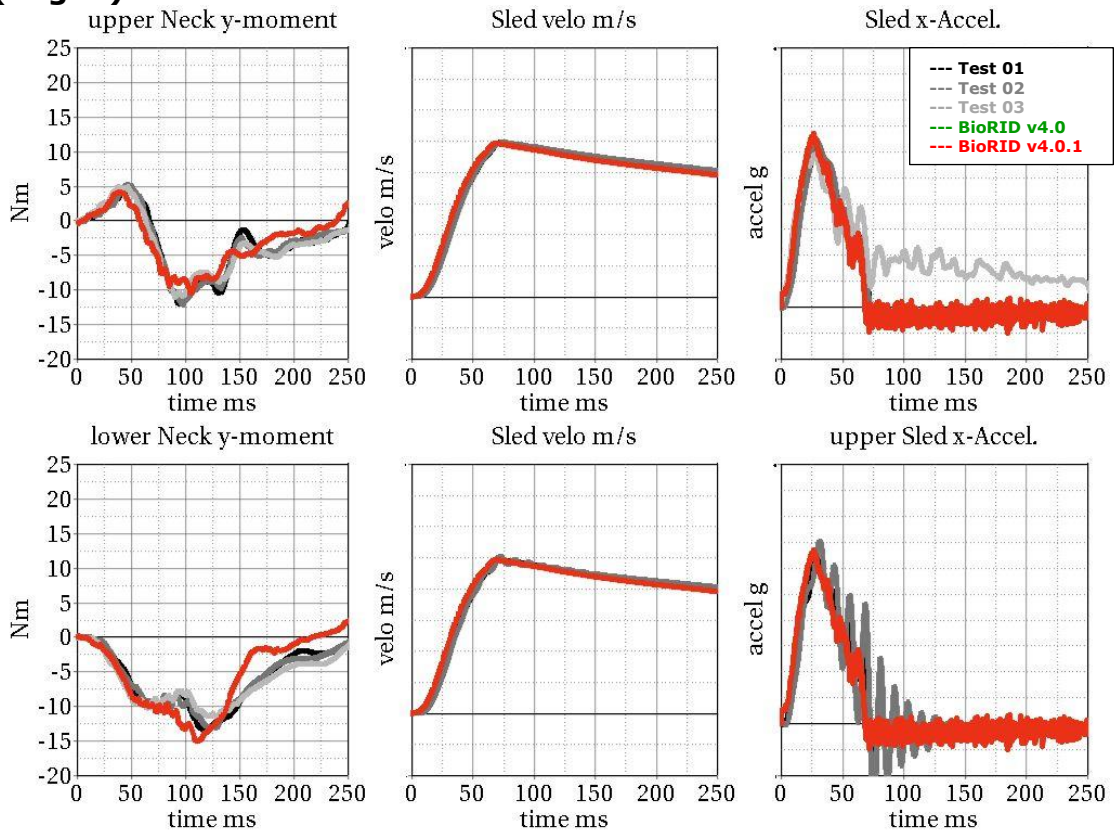




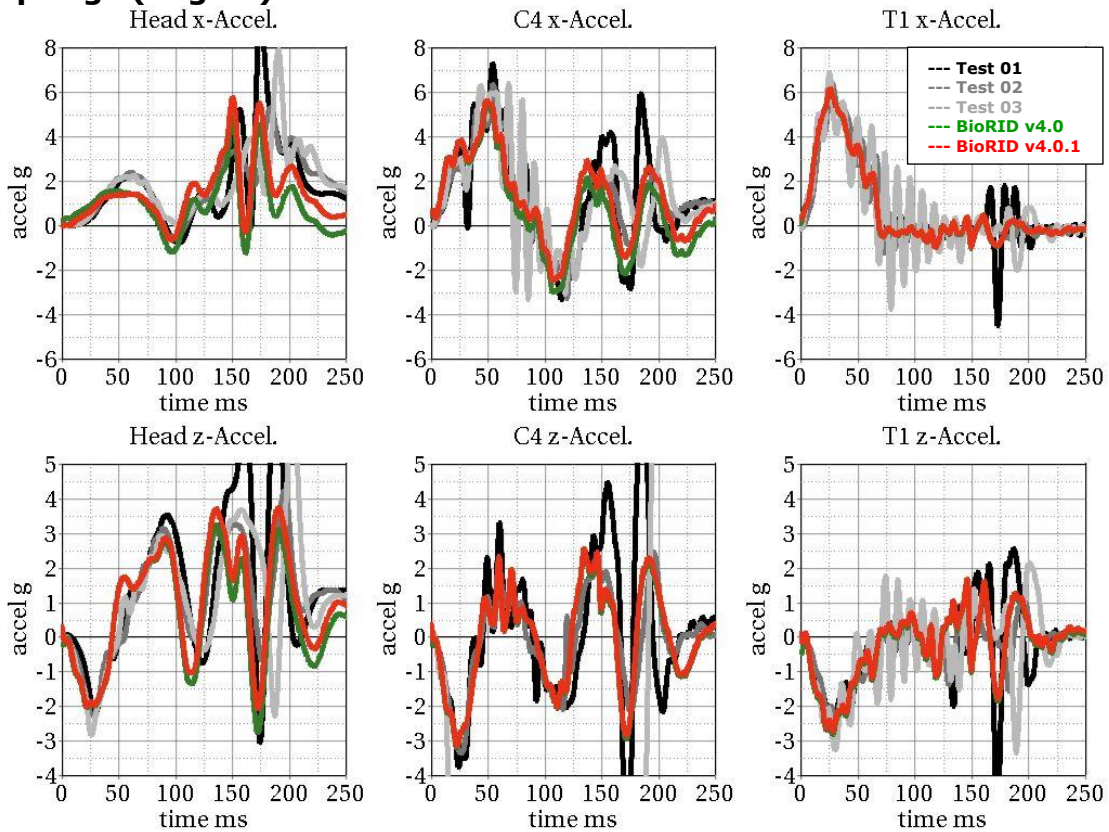
**Spine fixed up to T1 without damper/with muscle substitute springs  
(Page 2)**



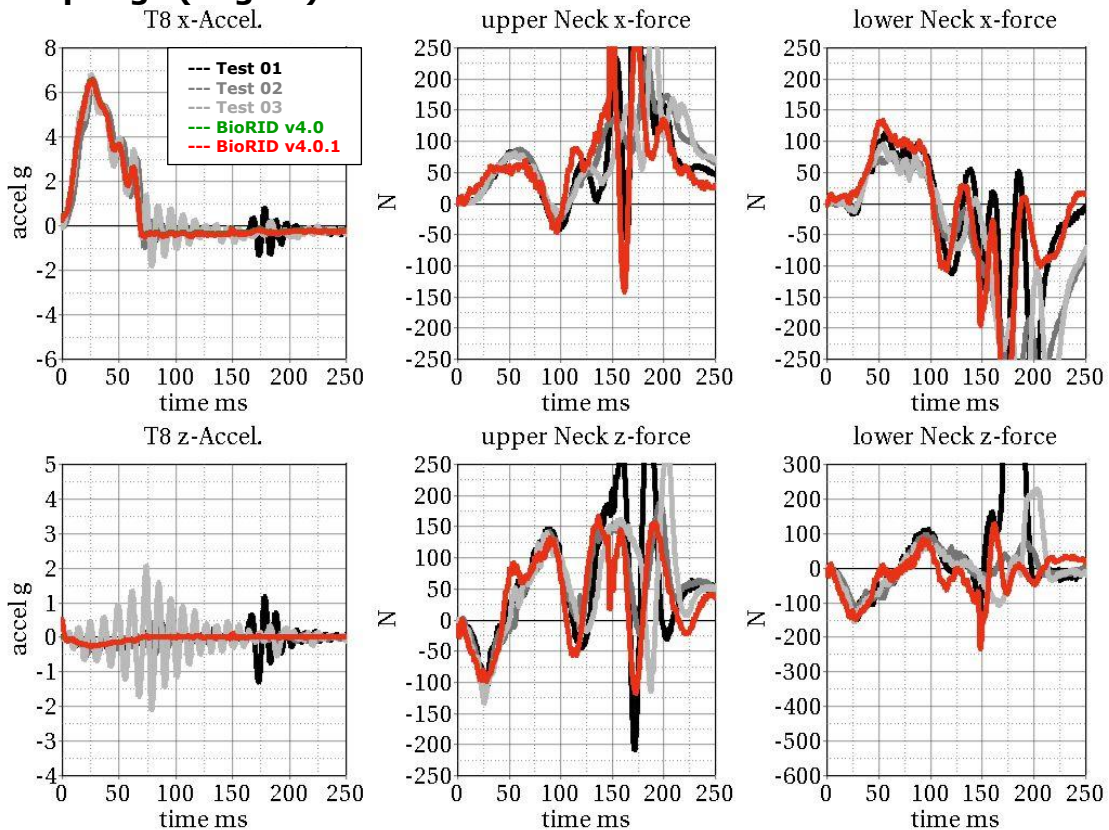
**Spine fixed up to T1 without damper/with muscle substitute springs  
(Page3)**



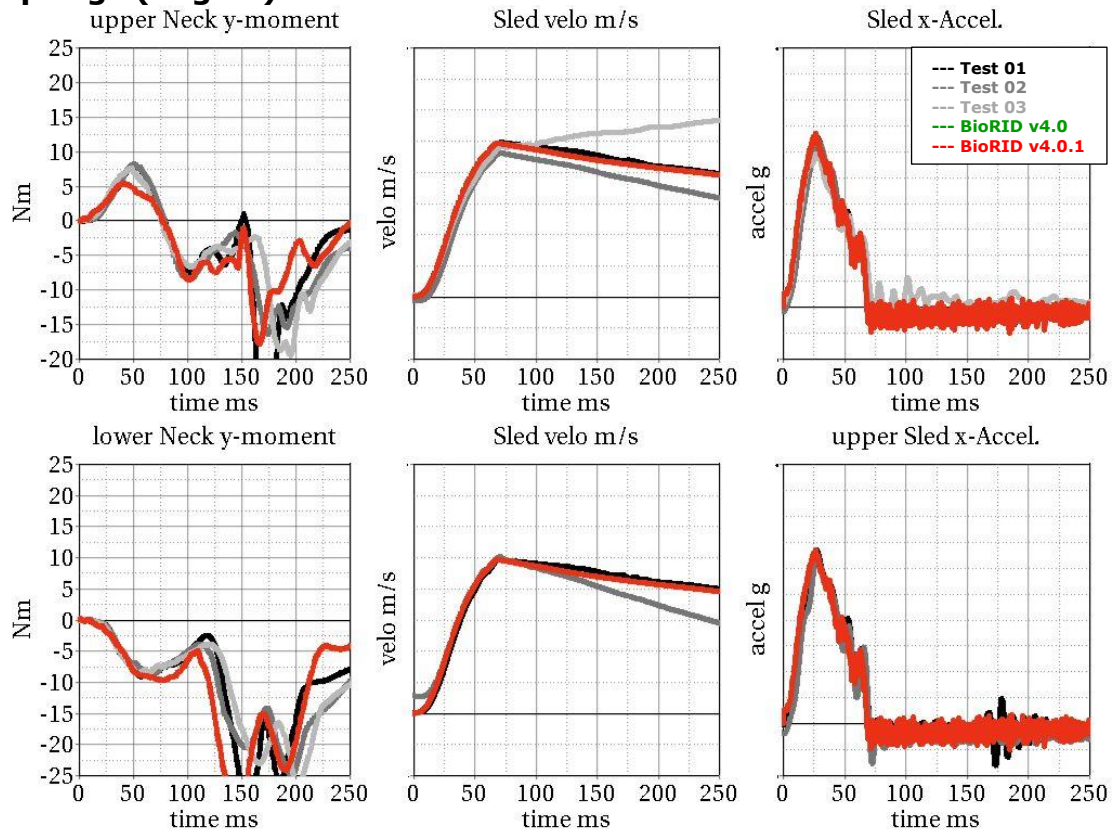
**Spine fixed up to T1 without damper/without muscle substitute springs (Page 1)**



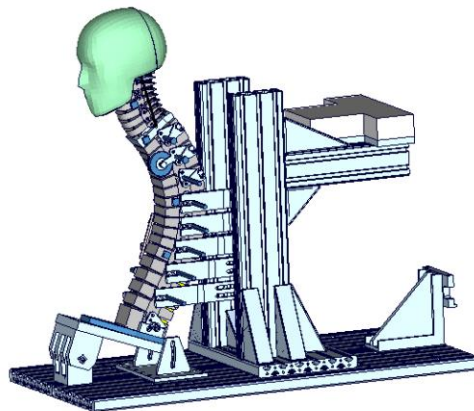
**Spine fixed up to T1 without damper/without muscle substitute springs (Page 2)**



**Spine fixed up to T1 without damper/without muscle substitute springs (Page 3)**

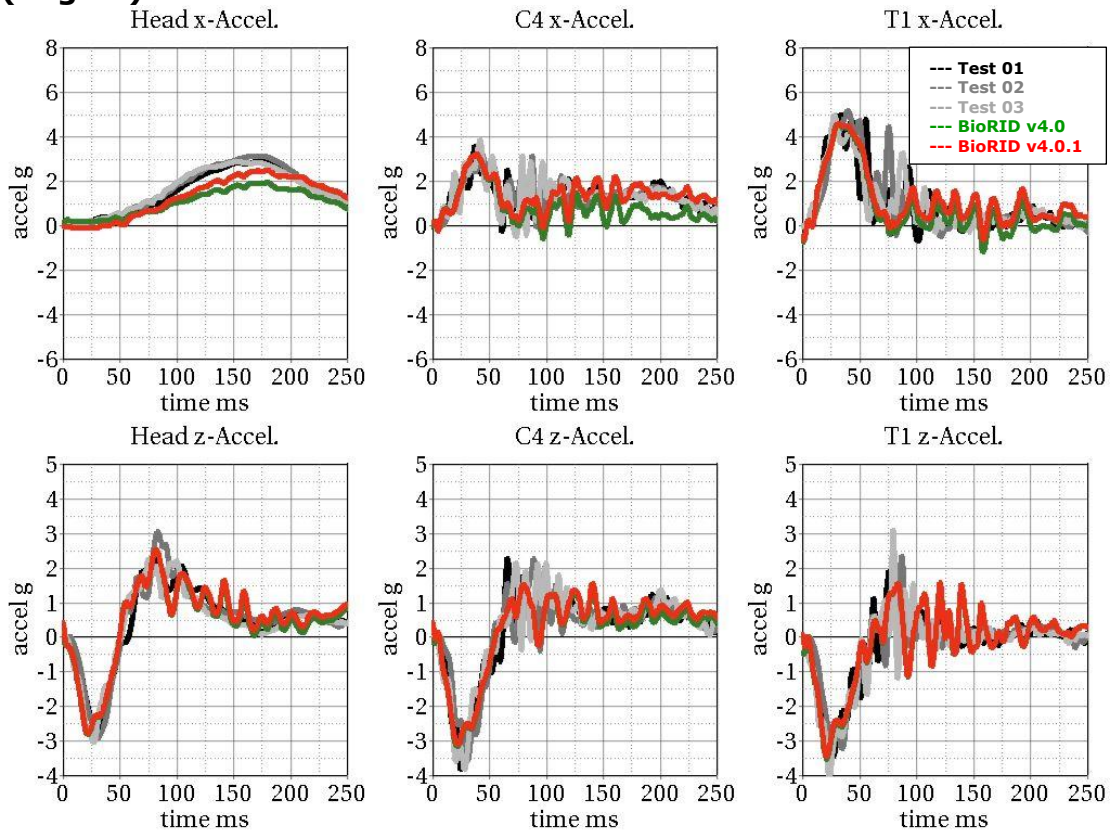


**7.1.2 Results of spine fixed up to T8**

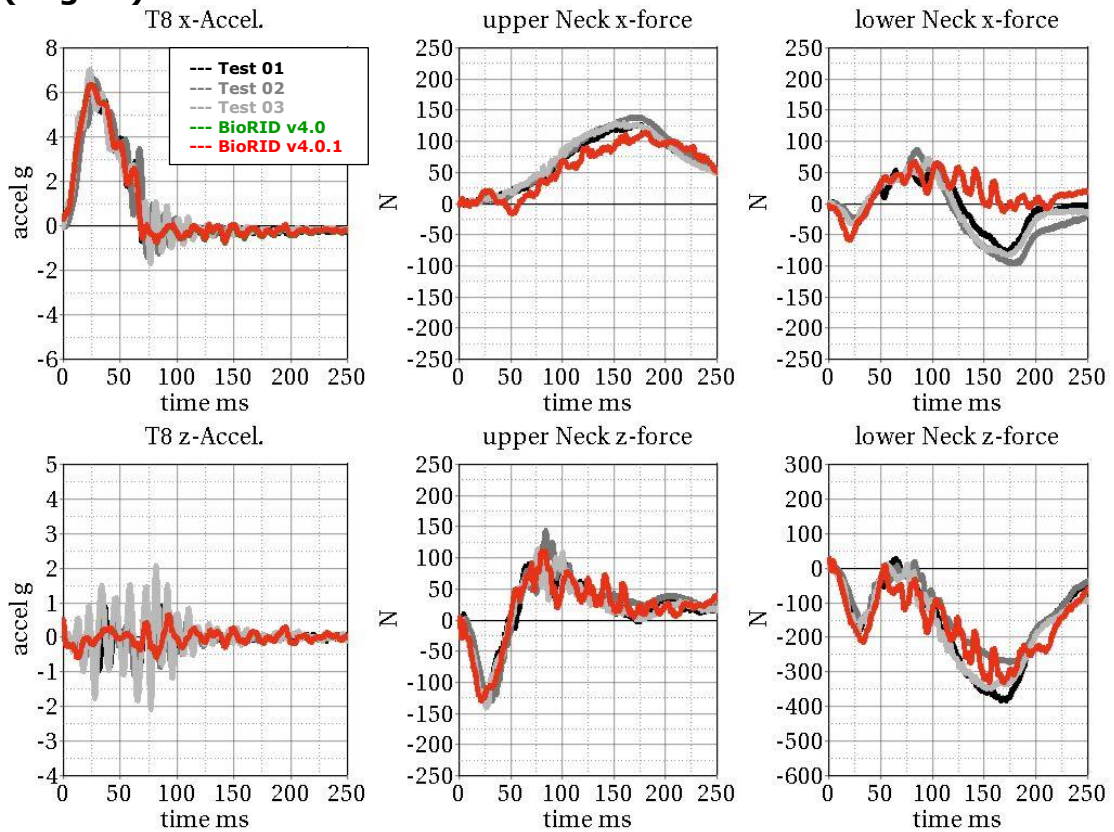


**Figure 22:** Spine fixed up to T8.

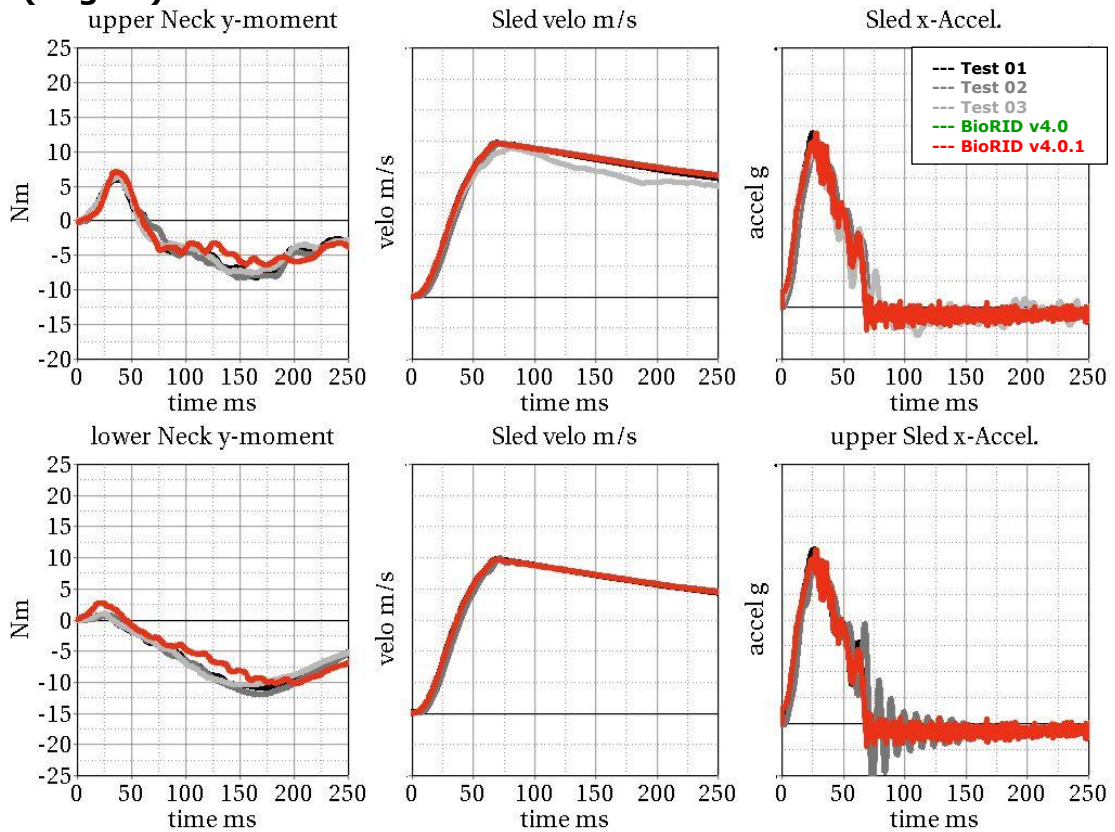
**Spine fixed up to T8 with damper/with muscle substitute springs (Page 1)**



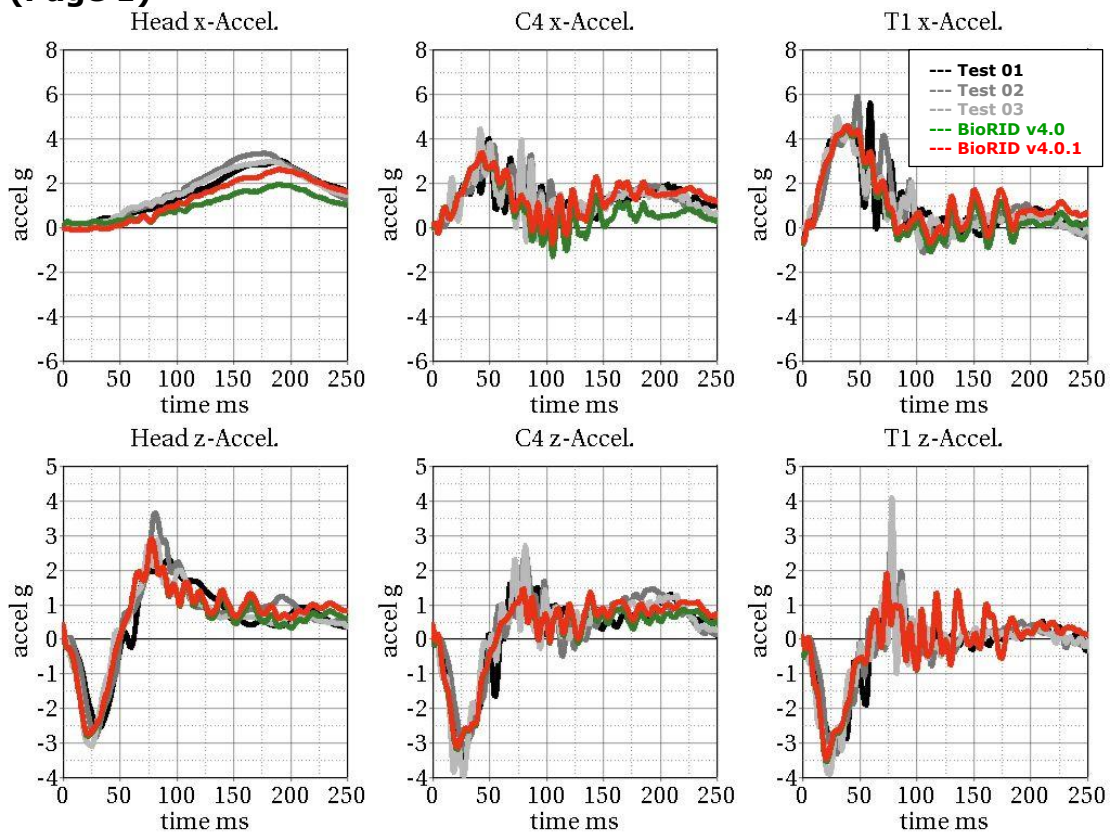
**Spine fixed up to T8 with damper/with muscle substitute springs (Page 2)**



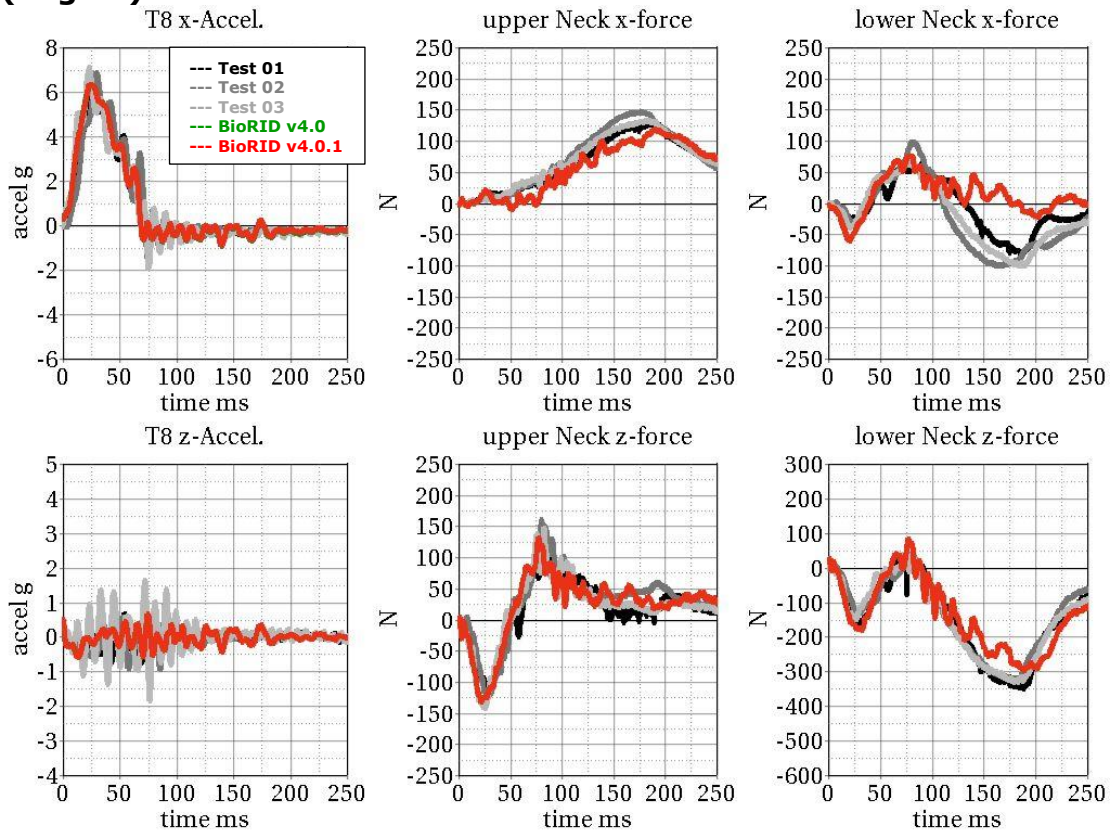
**Spine fixed up to T8 with damper/with muscle substitute springs (Page 3)**



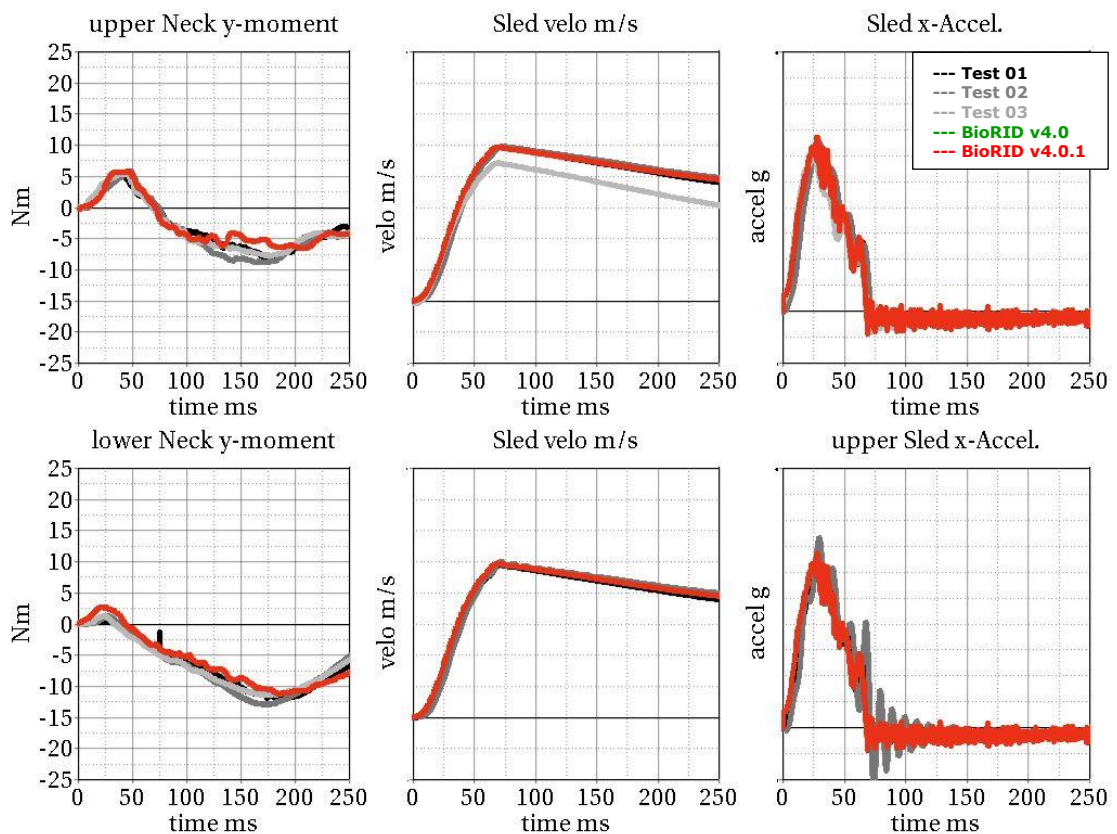
**Spine fixed up to T8 without damper/with muscle substitute springs (Page 1)**



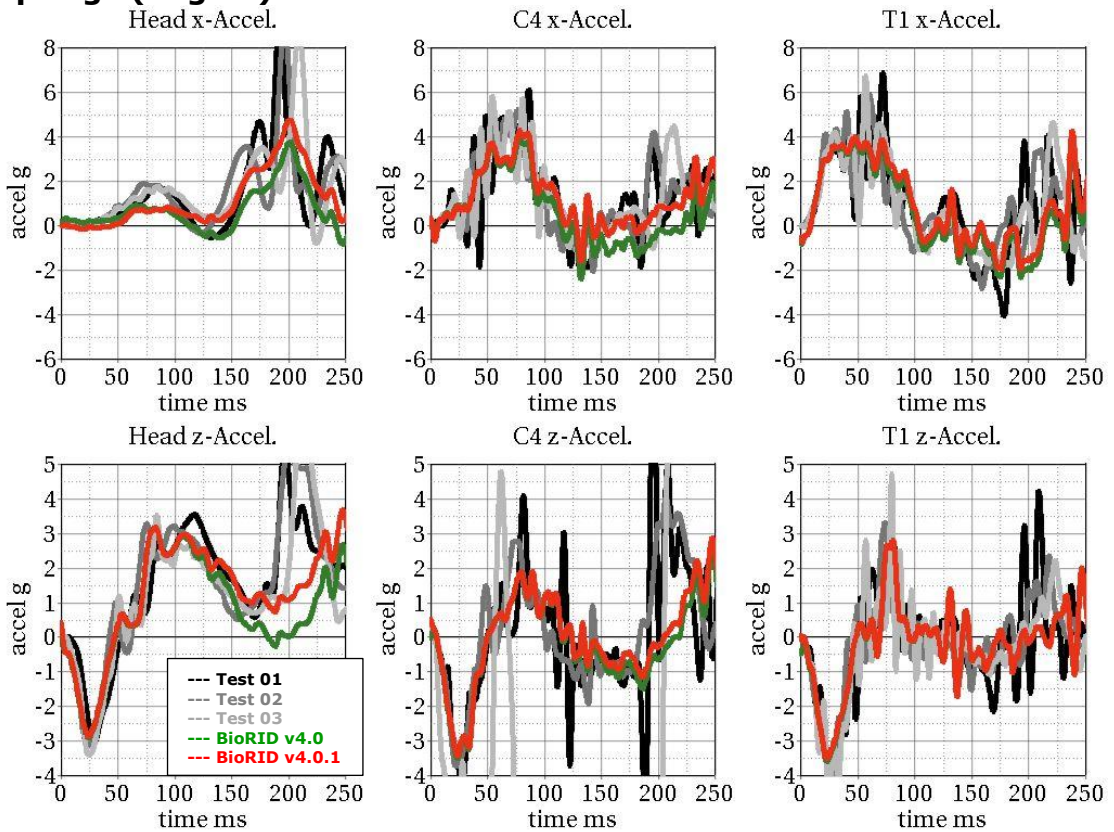
**Spine fixed up to T8 without damper/with muscle substitute springs (Page 2)**



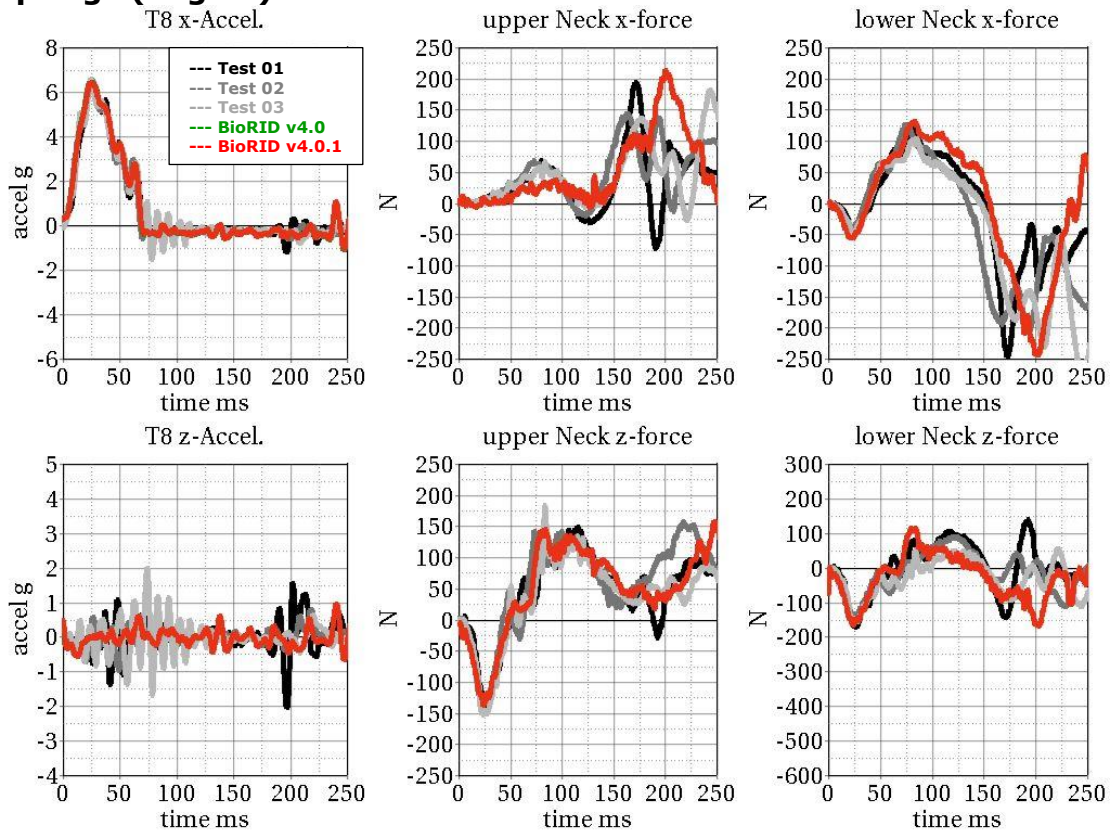
**Spine fixed up to T8 without damper/with muscle substitute springs (Page 3)**



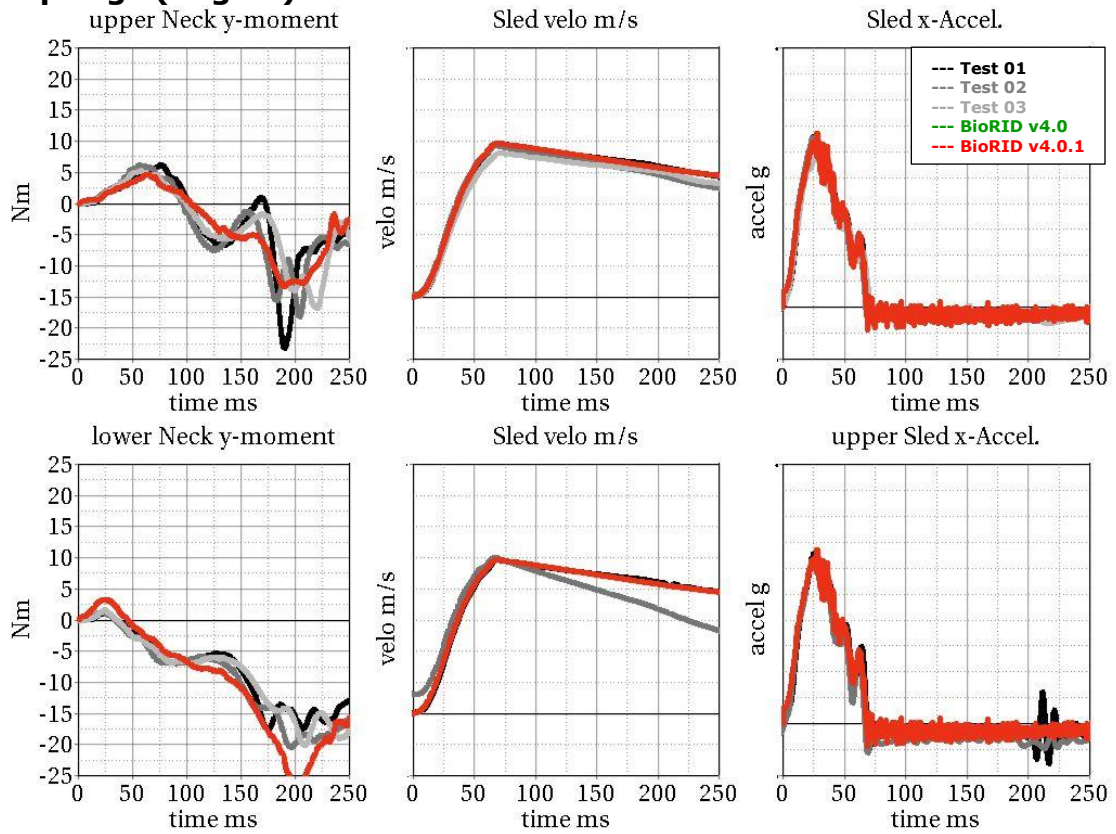
**Spine fixed up to T8 without damper/without muscle substitute springs (Page 1)**



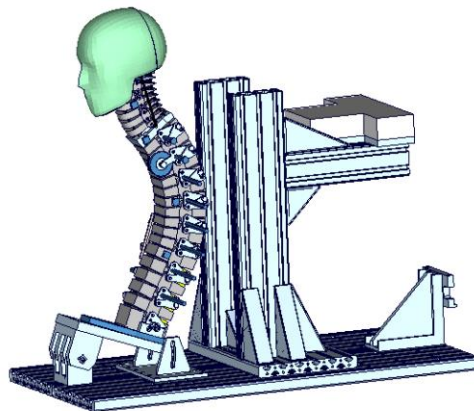
**Spine fixed up to T8 without damper/without muscle substitute springs (Page 2)**



**Spine fixed up to T8 without damper/without muscle substitute springs (Page 3)**



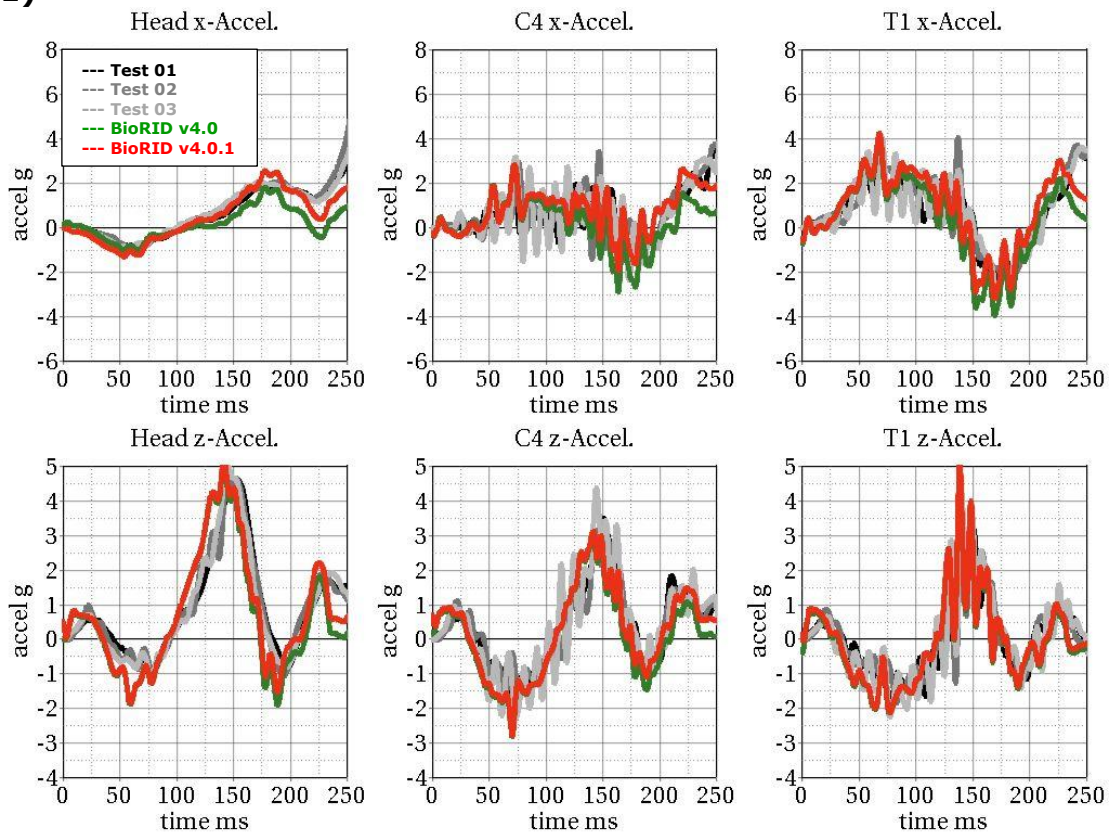
**7.1.3 Results of spine fixed up to L6**



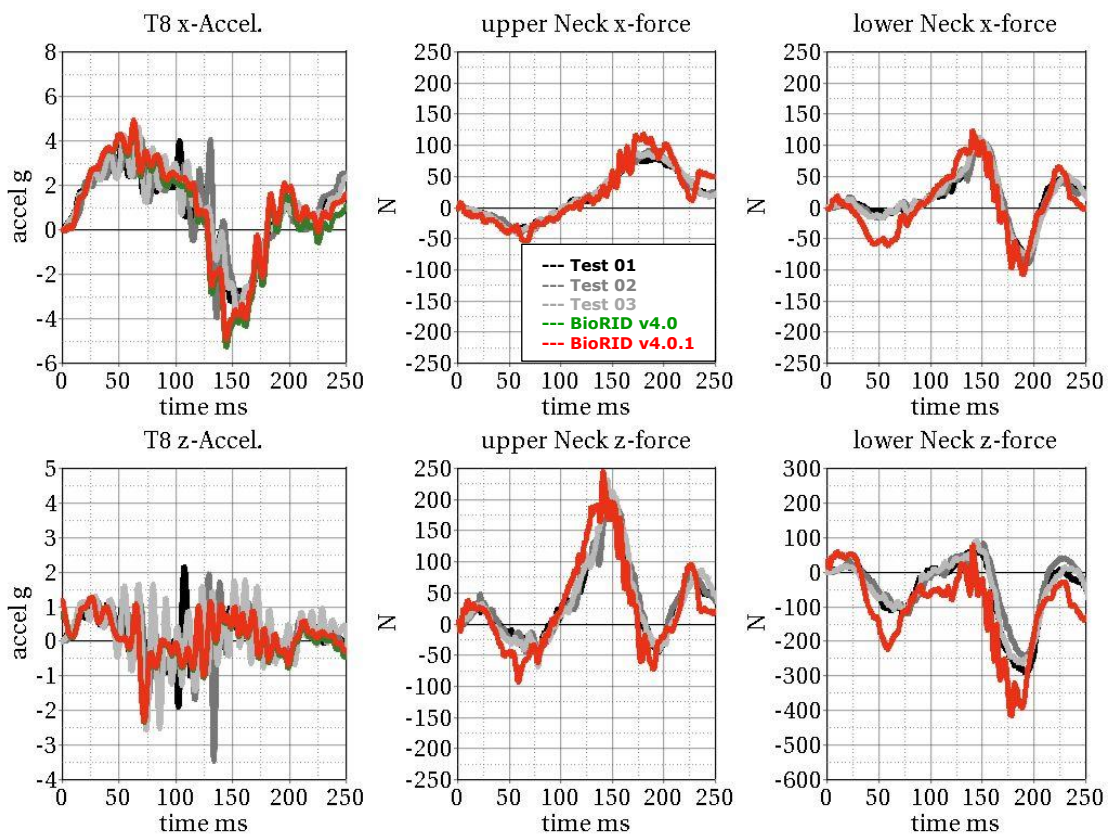
**Figure 23:** Spine fixed up to L6.



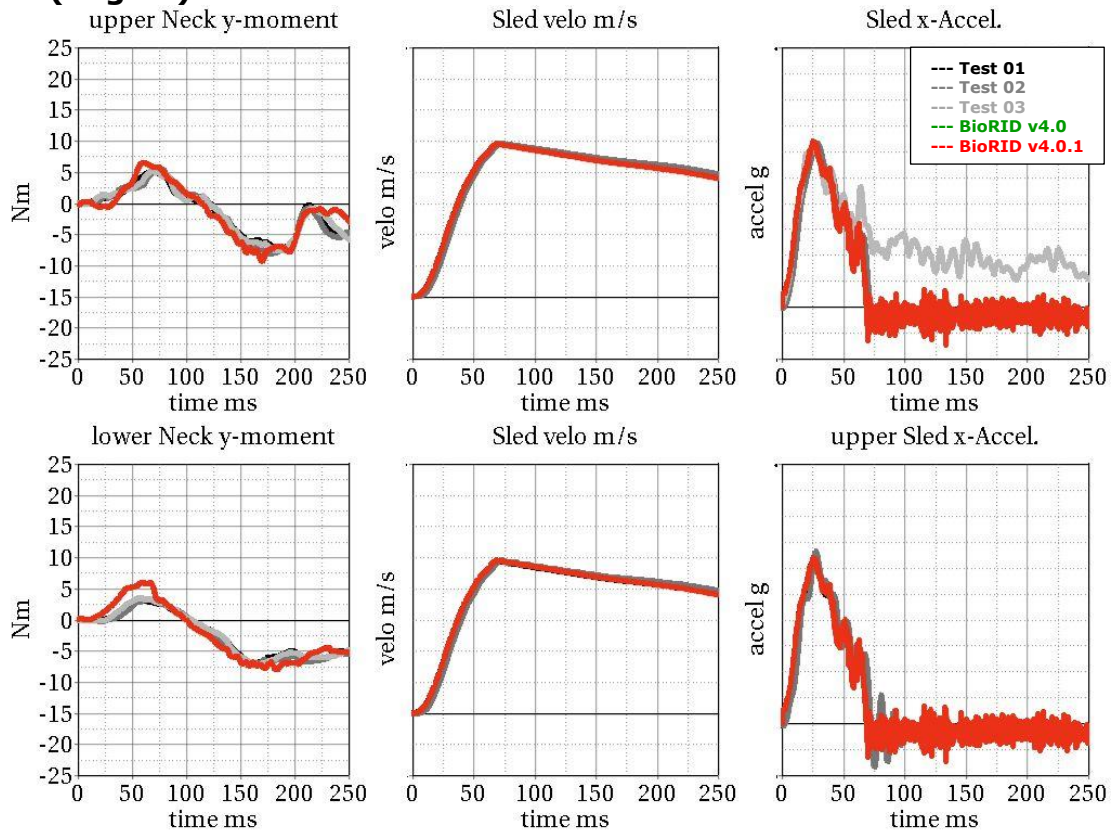
**Spine fixed up to L6 with damper/with muscle substitute springs (Page 1)**



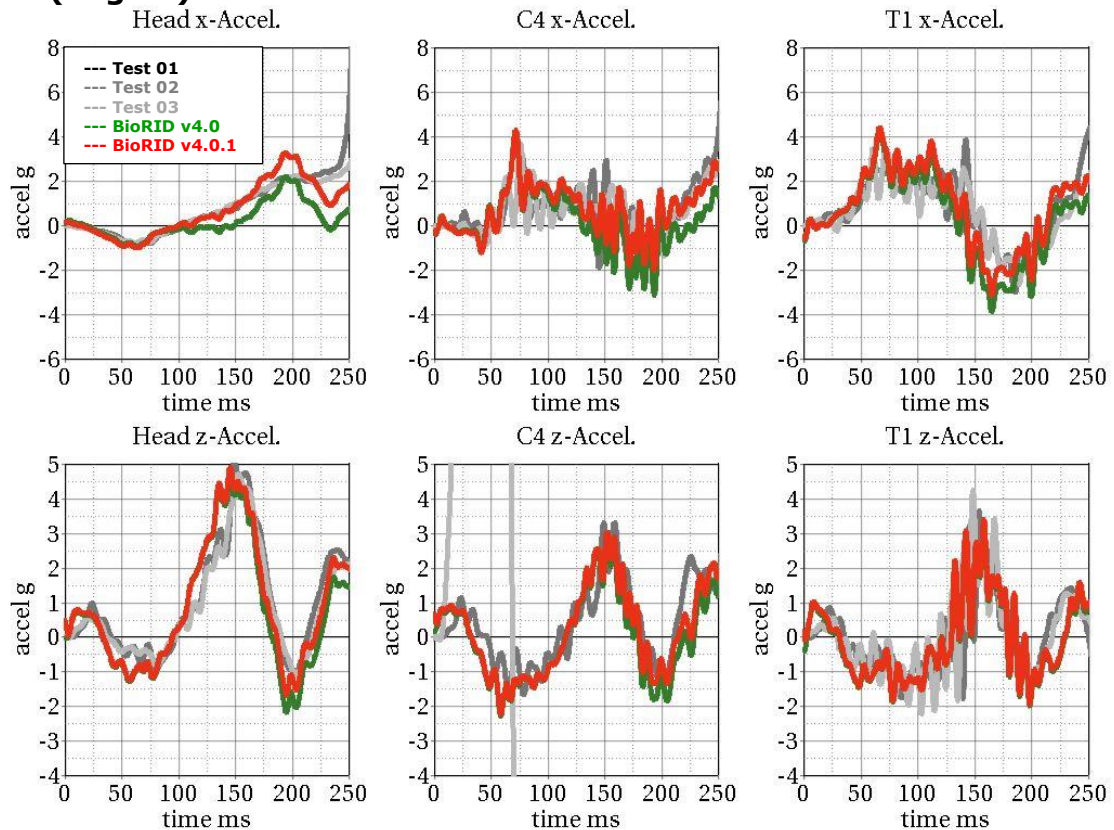
**Spine fixed up to L6 with damper/with muscle substitute springs (Page 2)**



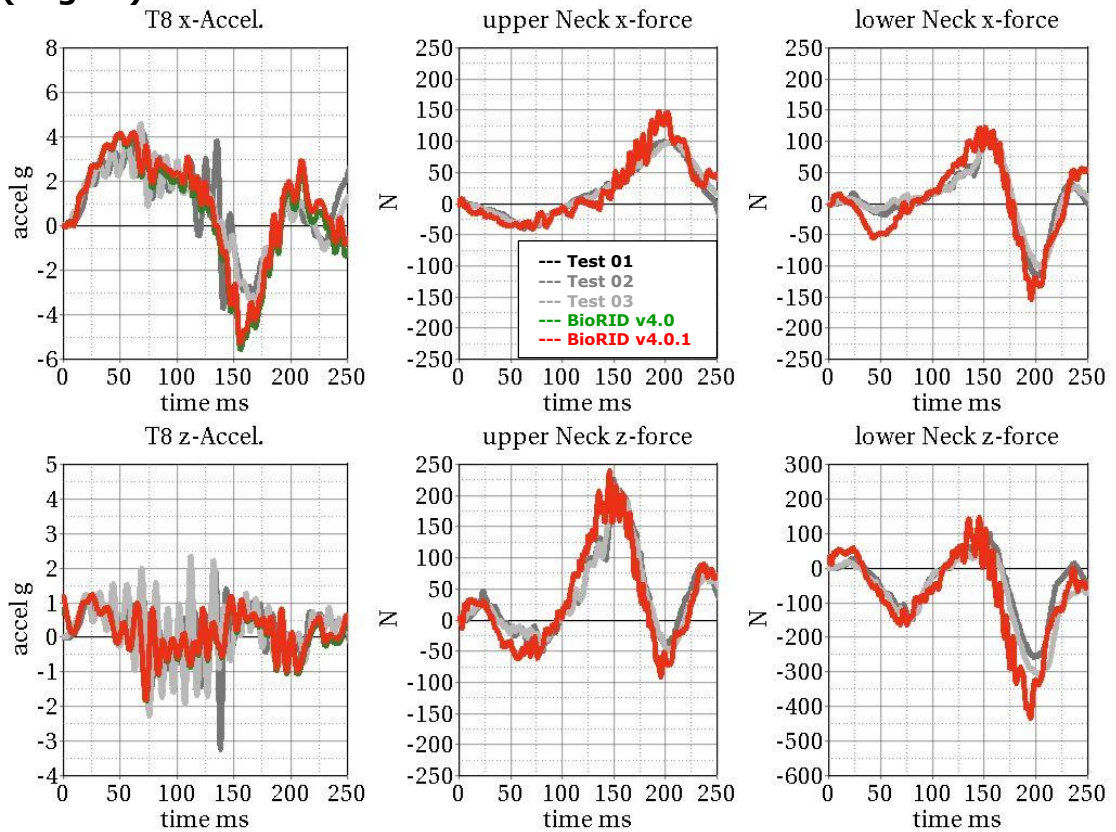
**Spine fixed up to L6 with damper/with muscle substitute springs (Page 3)**



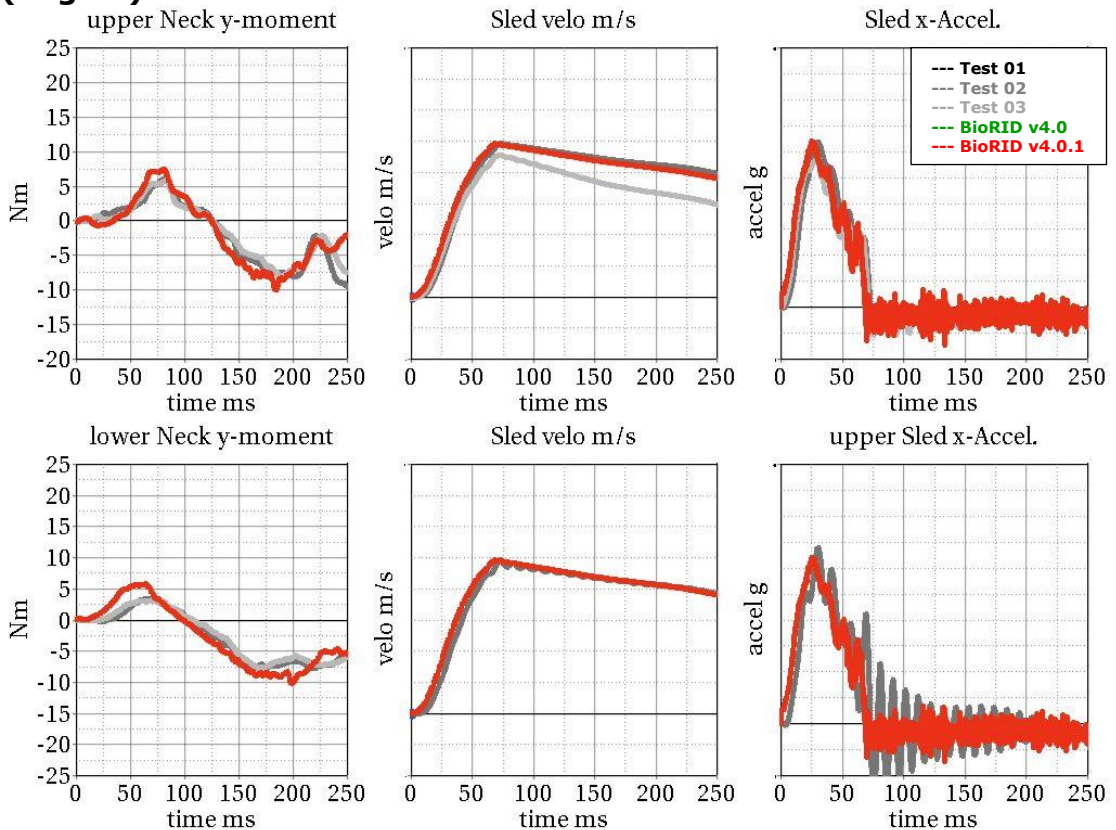
**Spine fixed up to L6 without damper/with muscle substitute springs (Page 1)**



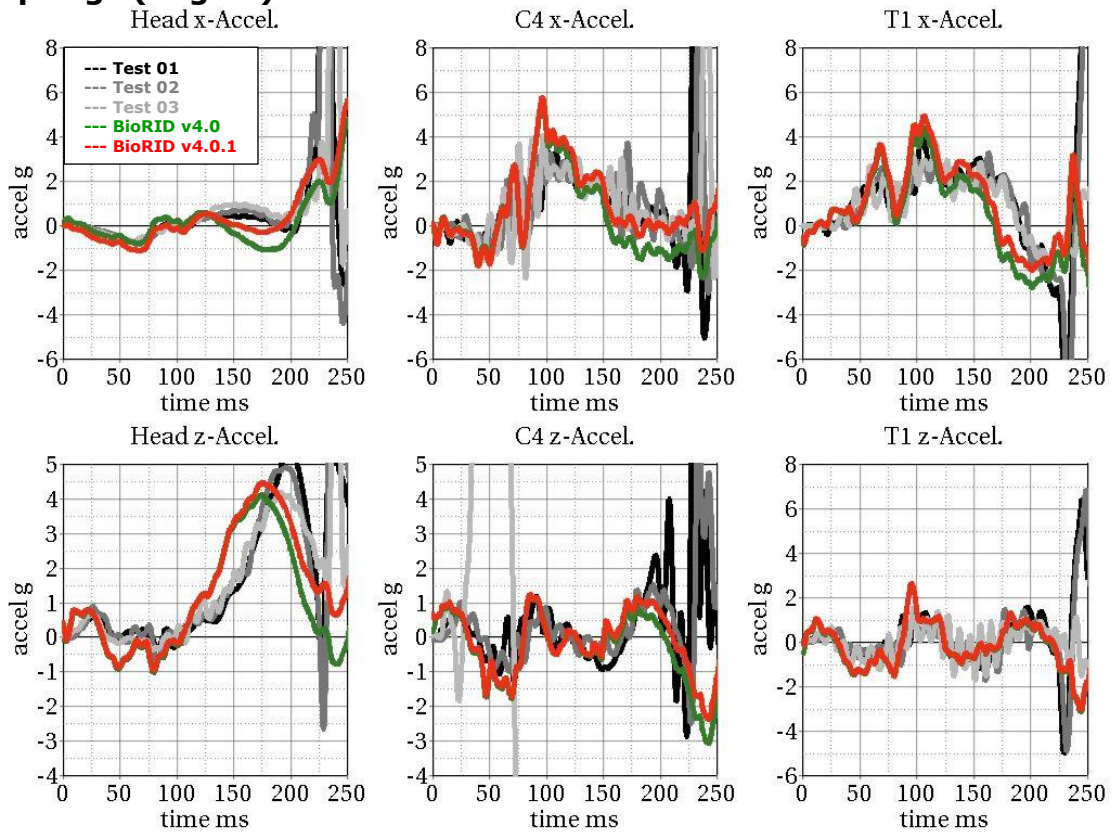
**Spine fixed up to L6 without damper/with muscle substitute springs (Page 2)**



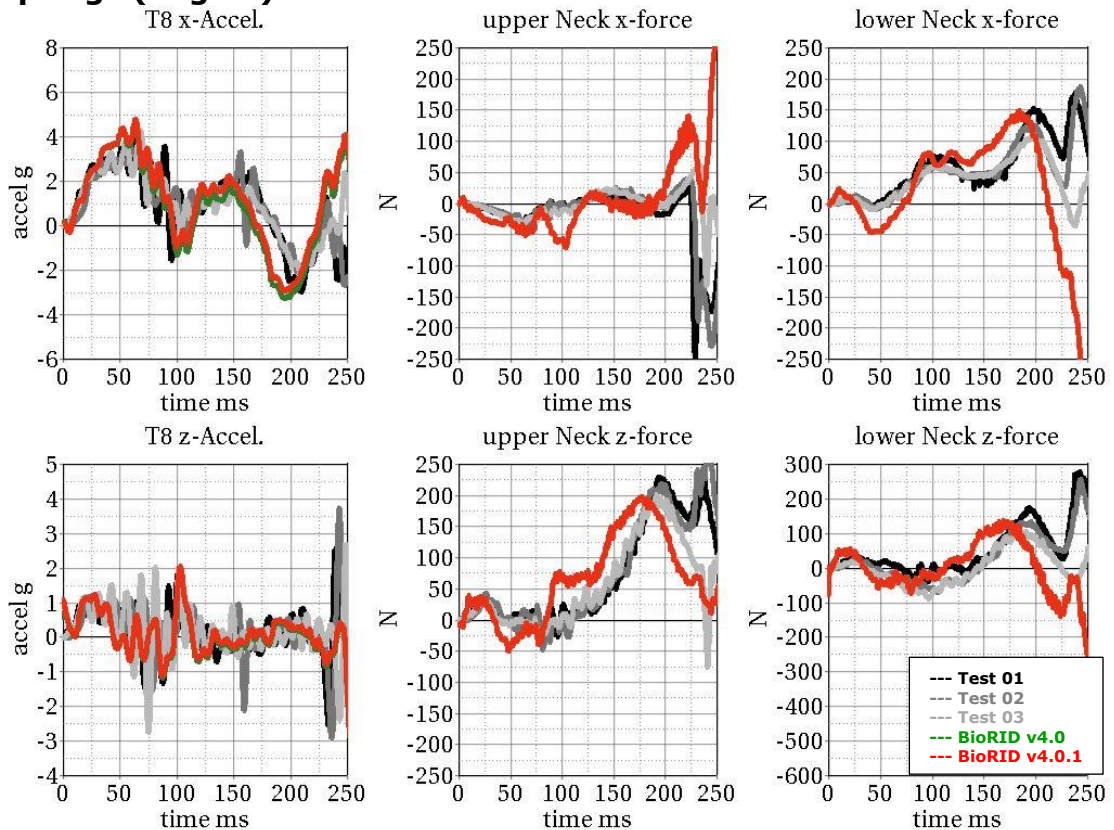
**Spine fixed up to L6 without damper/with muscle substitute springs (Page 3)**



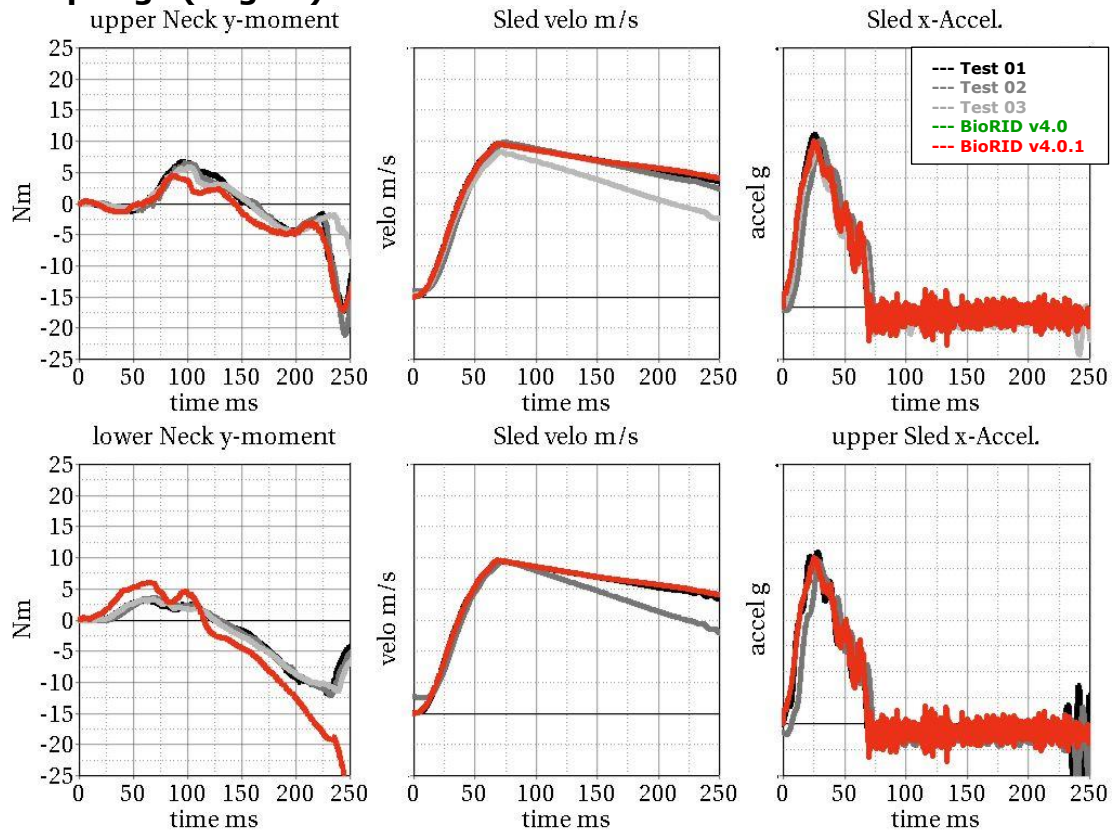
**Spine fixed up to L6 without damper/without muscle substitute springs (Page 1)**



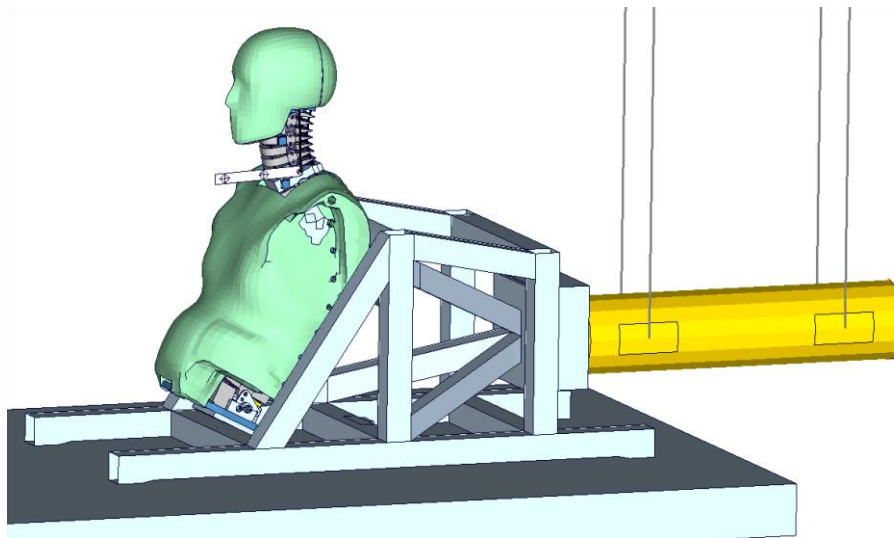
**Spine fixed up to L6 without damper/without muscle substitute springs (Page 2)**



**Spine fixed up to L6 without damper/without muscle substitute springs (Page 3)**



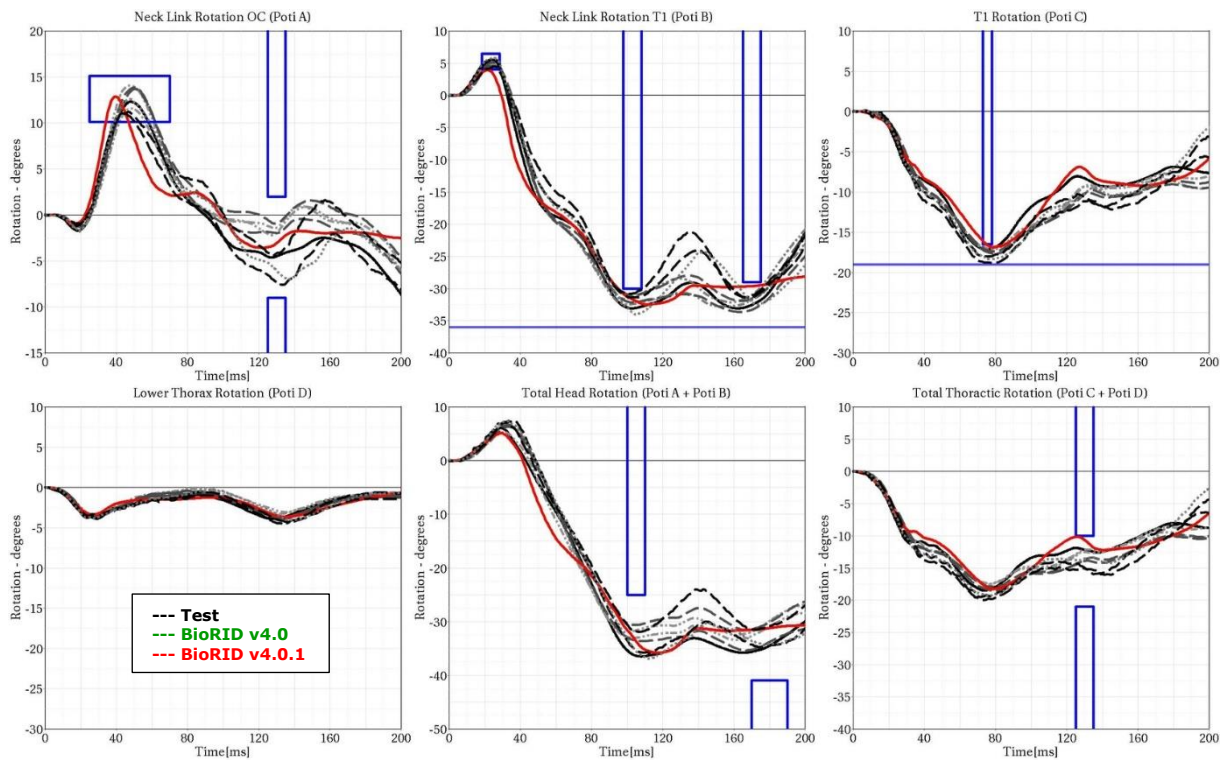
## 7.2 Guided sled Calibration test results



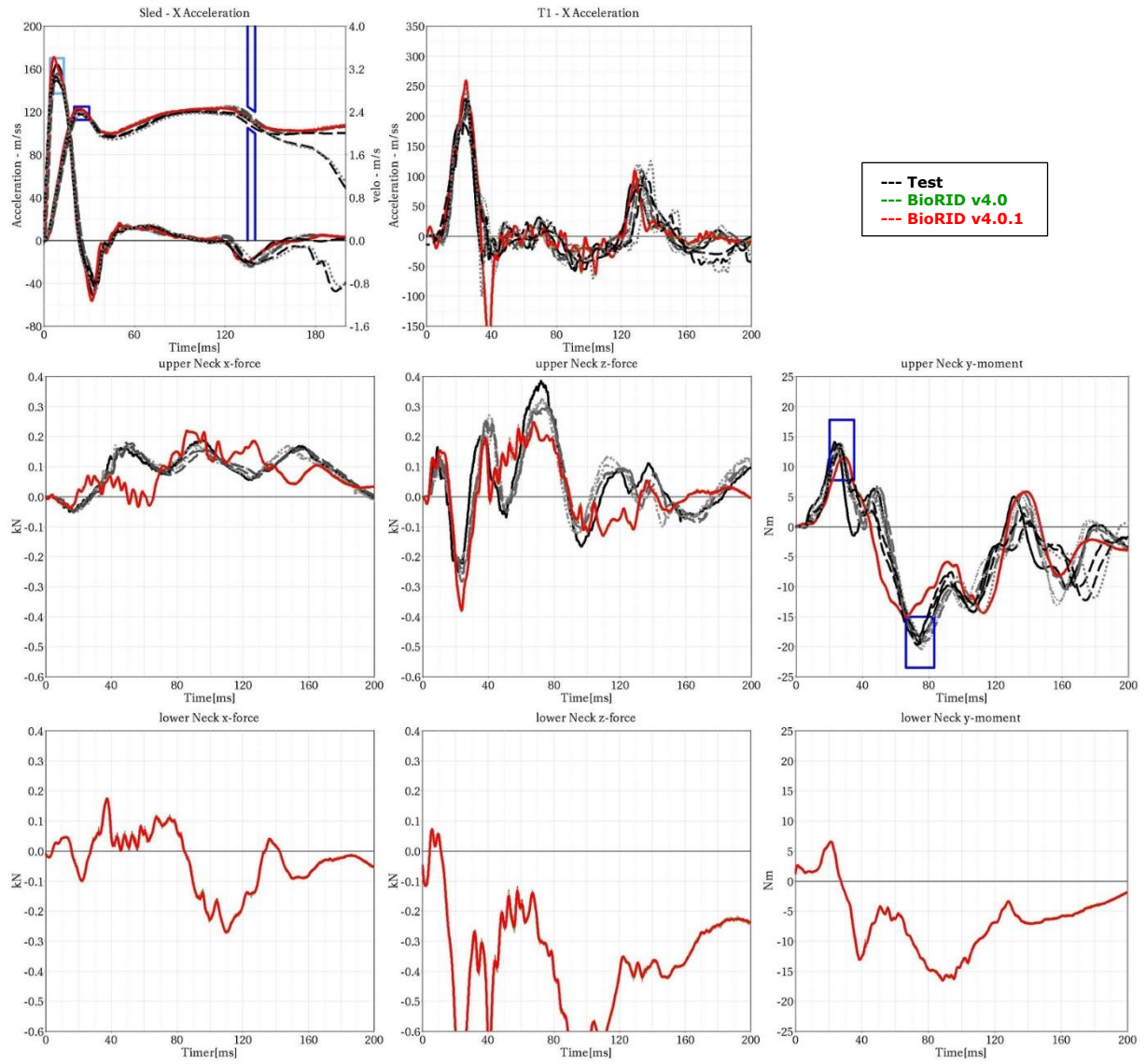
**Figure 24:** Calibration test setup.

The calibration test setup is done as described in the manual of the physical dummy (BioRID-II User's Guide Robert A. Denton, Inc., June 2002). The required corridors are the blue boxes and lines.

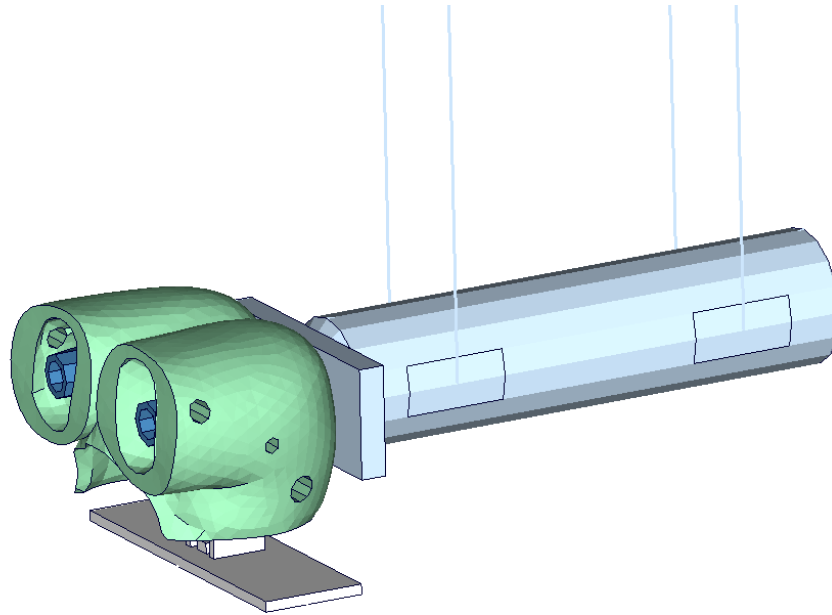
### Results of BioRID-II calibration test



# Performance



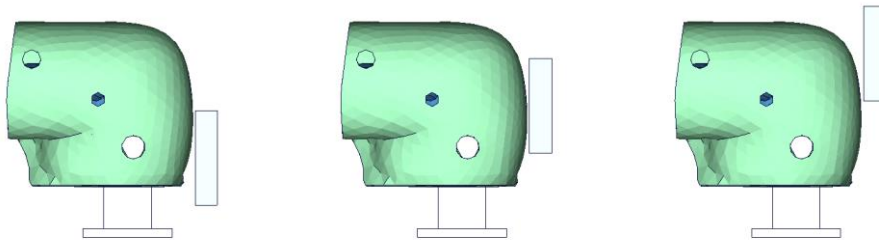
### 7.3 Pelvis test results



**Figure 25:** Pelvis test setup.

Due to some changes in the hardware of the BioRID pelvis flesh, new component tests on the pelvis flesh are performed. The tested pelvis components are using new material adjustments of the BioRID-II. Two different pelvis flesh components are used for testing.

The test is performed as shown in the picture above. For the target point of the pendulum, three different heights and two different velocities are used.

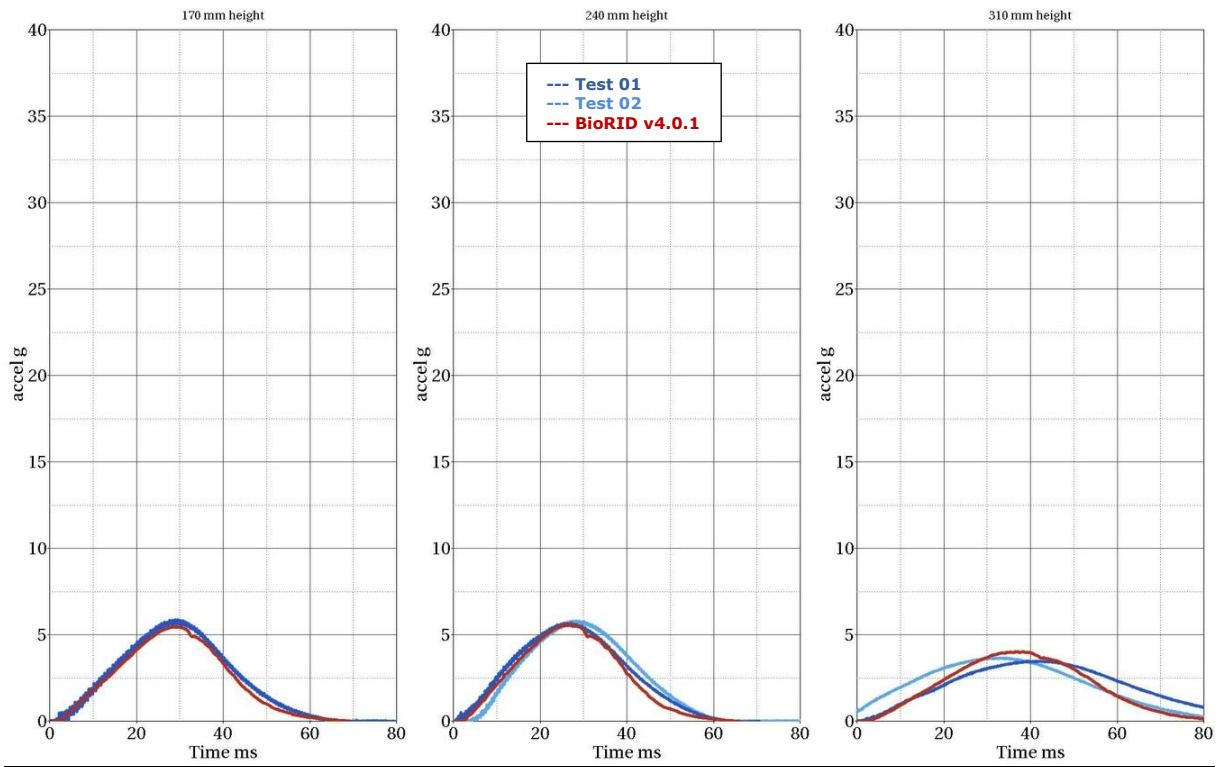


**Figure 26:** Pelvis test carried out at different heights

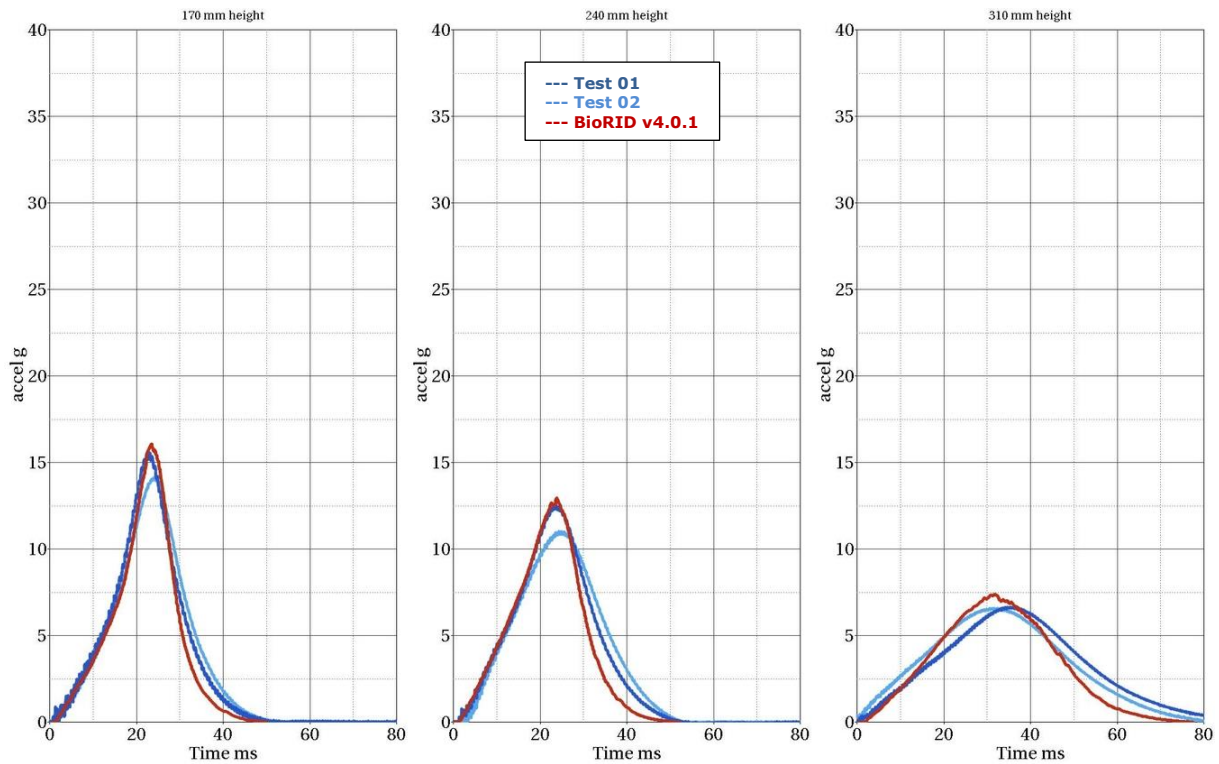
In version 3.0, v3.1, v3.6, v3.8, v3.9, v4.0 and v4.0.1 of the BioRID-II no changes are done to the Pelvis area. Thus the results of the version 2.5 are the same than for the version v4.0.1.



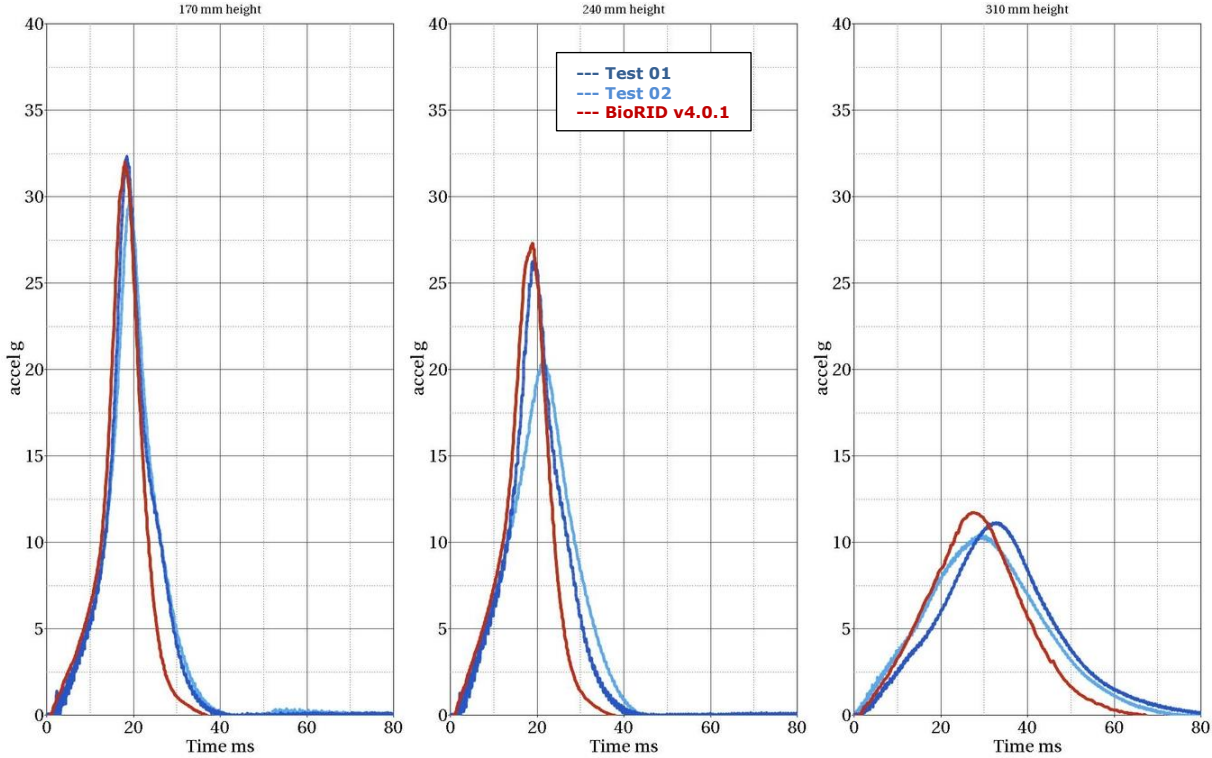
**Results of BioRID2 pelvis test - all heights, low velocity**



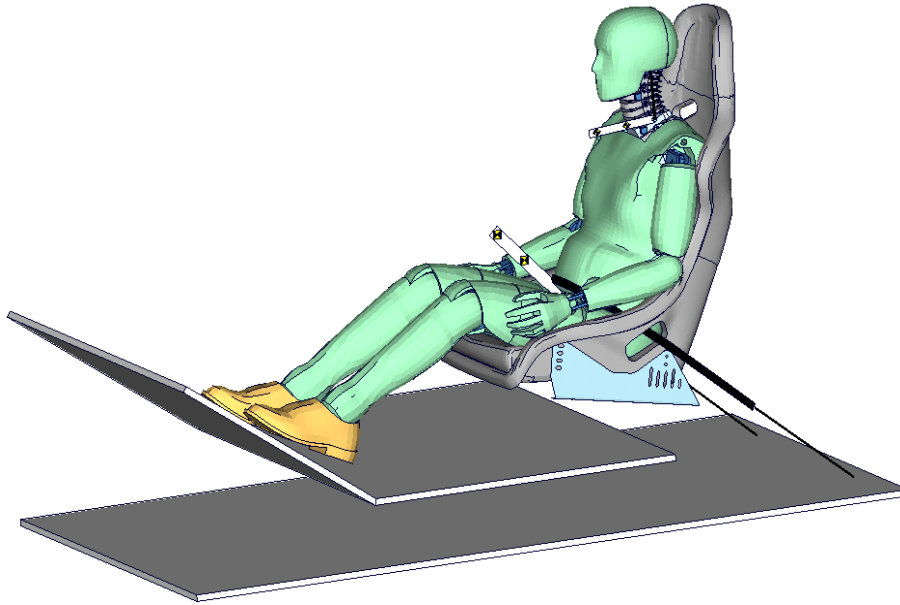
**Results of BioRID2 pelvis test - all heights, middle velocity**



**Results of BioRID2 pelvis test - all heights, high velocity**



## 7.4 Sports car seat results



**Figure 27:** Whiplash seat.

Due to the new pelvis stiffness and also to get smoother results of the BioRID for validation of the whole Dummy model, new tests are performed in a sports car seat. The used seat is depicted in the picture above.

SRA16 pulse	16 km/h plateau
IIWPG pulse	16 km/h triangle

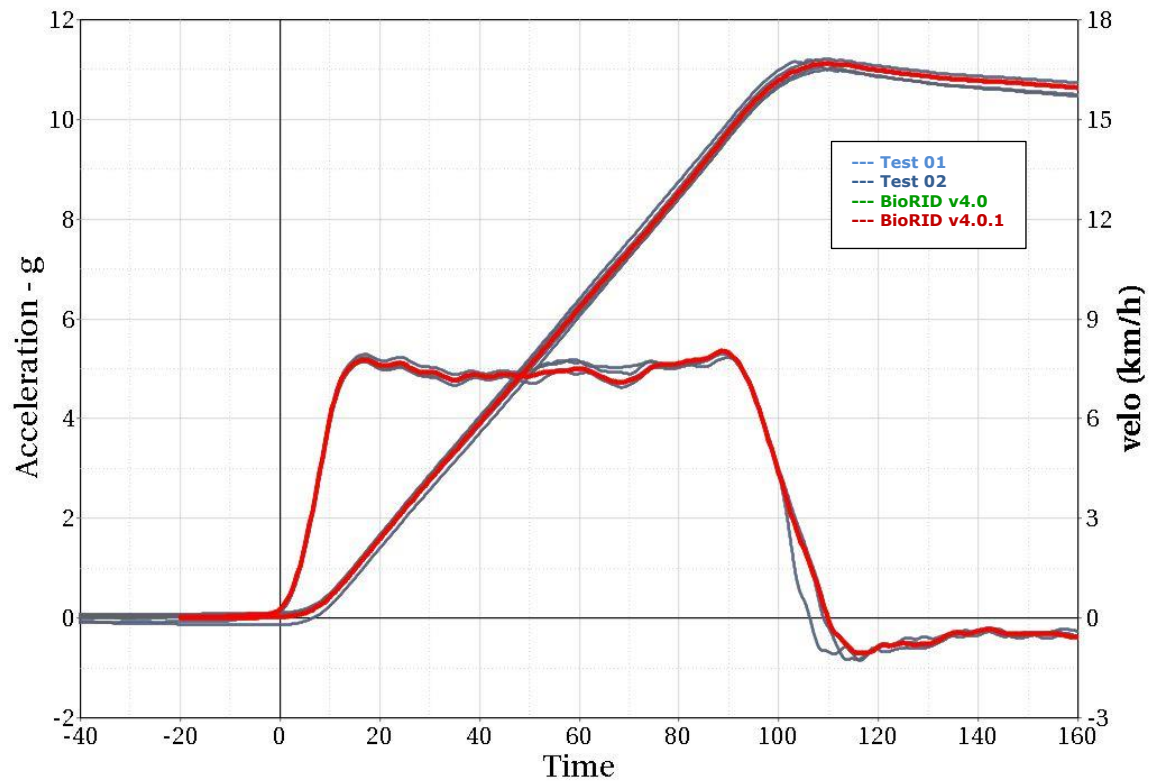
Before the tests, the position of the dummy was measured very accurately. Additionally, the position of the arms in simulation is adjusted very accurately to the test position. The influence of the arm position has a major influence on the results of the neck load cells.

The pre-stress is used for the complete model including BioRID and Seat model.

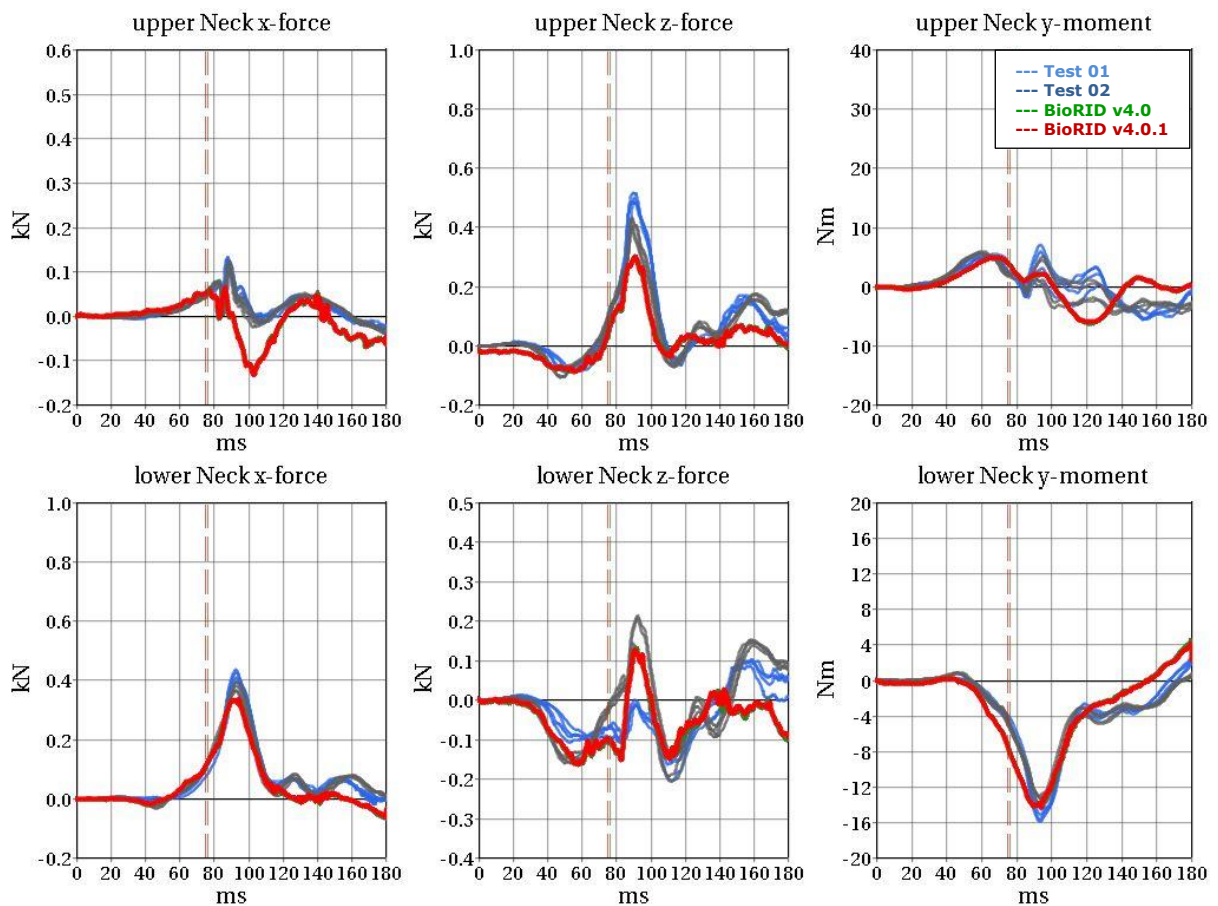
In the following the results of the BioRID-II v4.0.1 are the red lines. The green lines are the results of the BioRID-II v4.0. All other curves are test data. All grey curves are a first BioRID and all blue curves are a second BioRID in test.

**Page 1 SRA16 pulse**

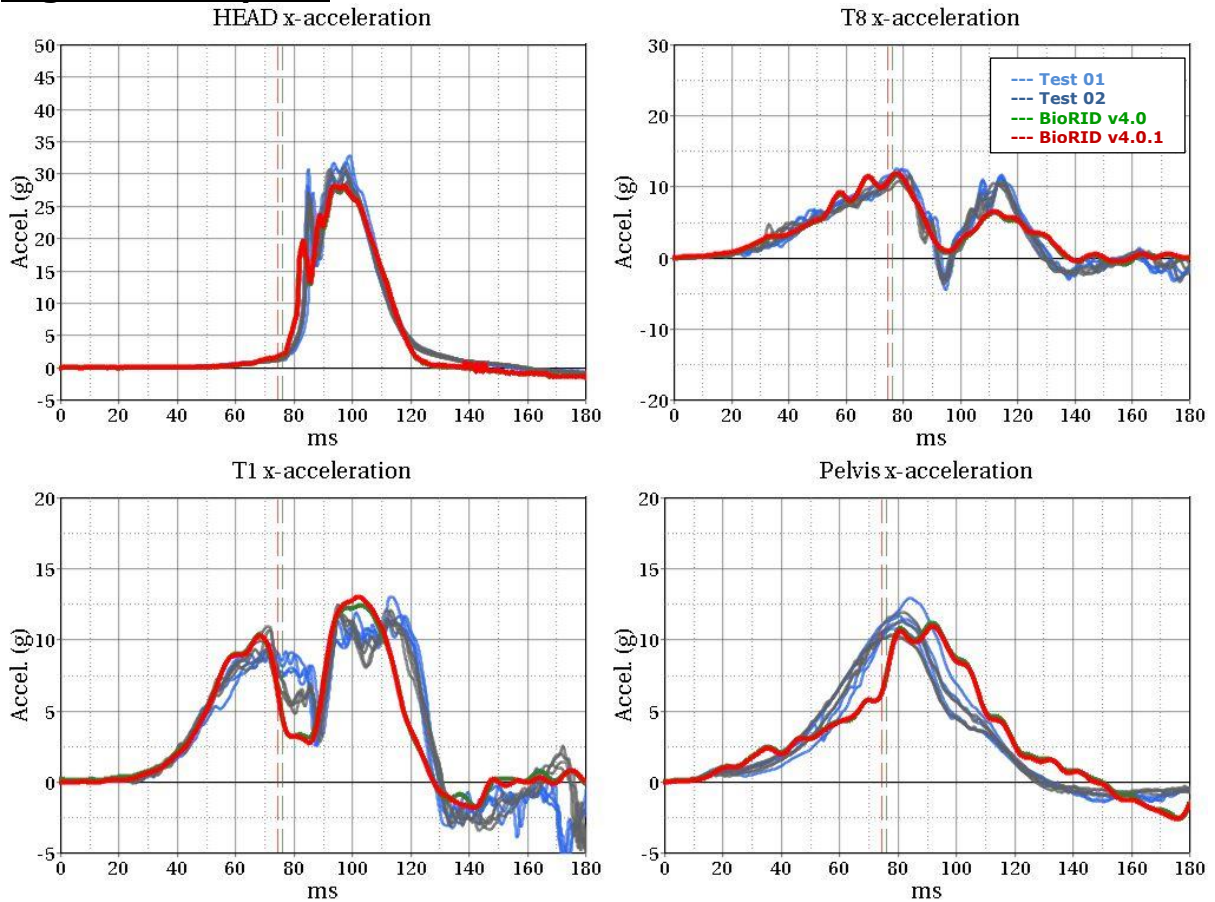
**Doppelschlitten HYBER-G Daimler  
SRA16 Puls**



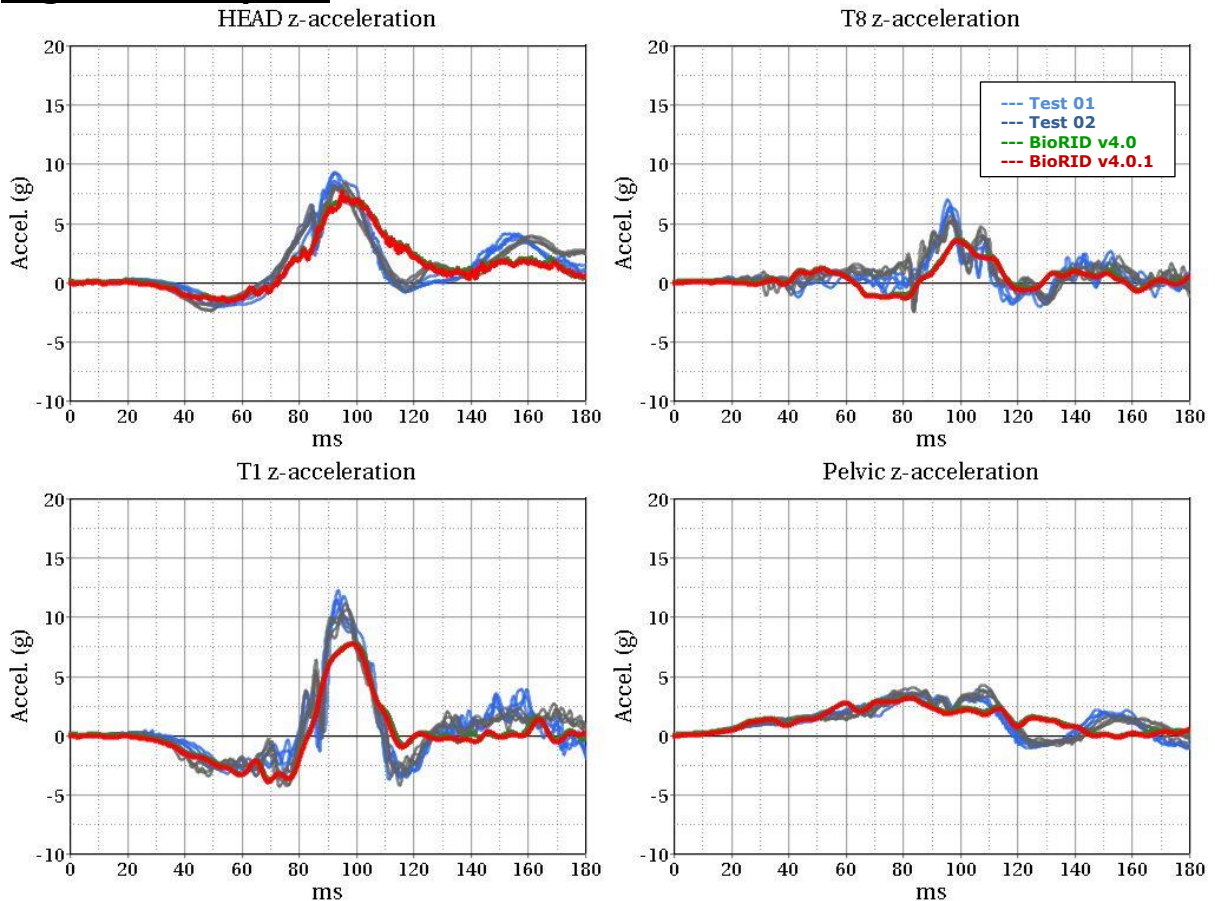
**Page 2 SRA16 pulse**



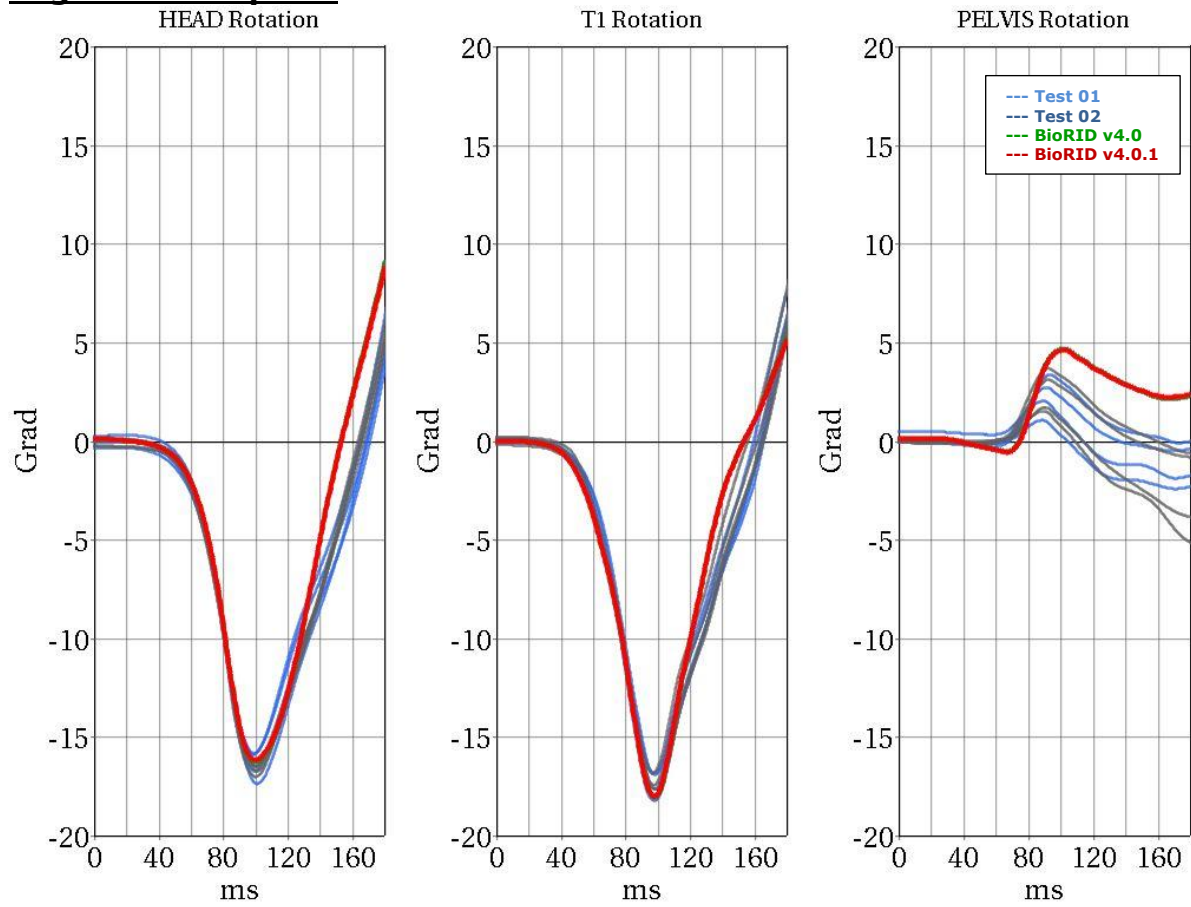
**Page 3 SRA16 pulse**



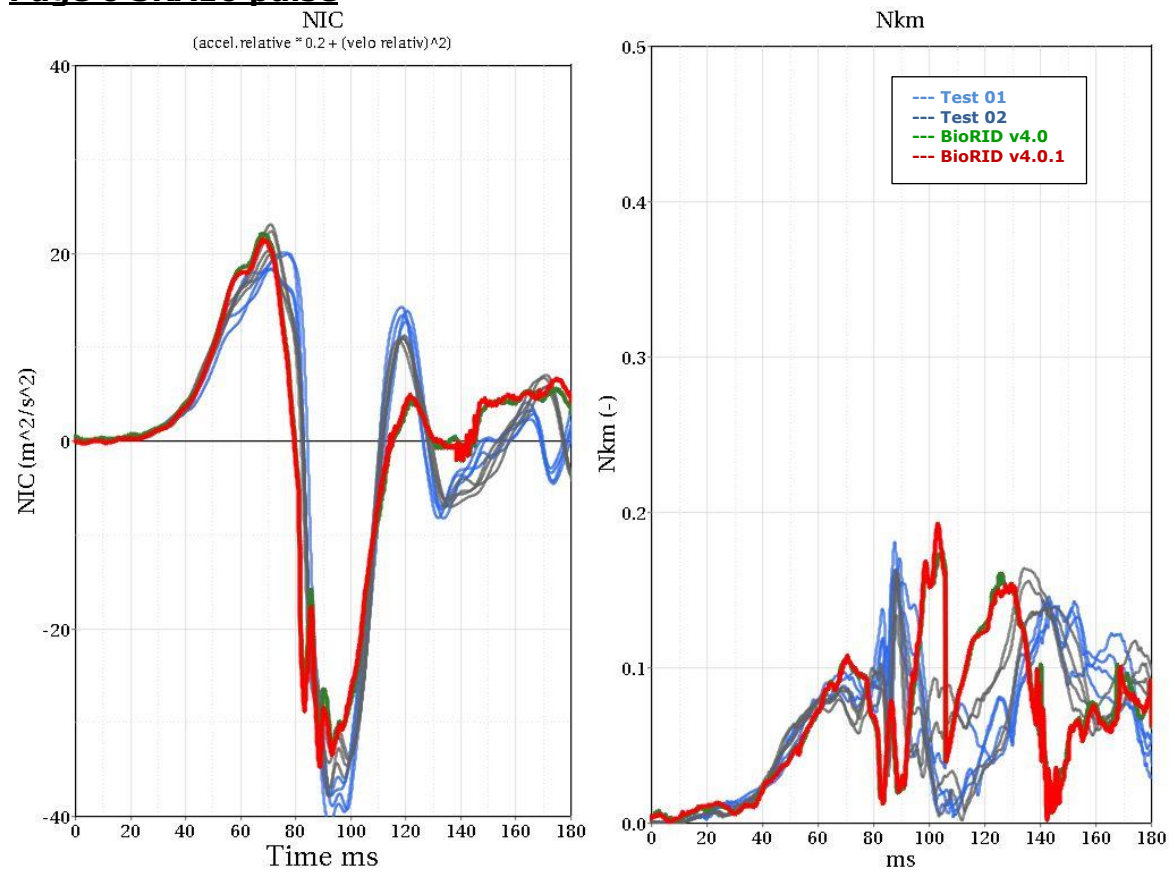
**Page 4 SRA16 pulse**



**Page 5 SRA16 pulse**

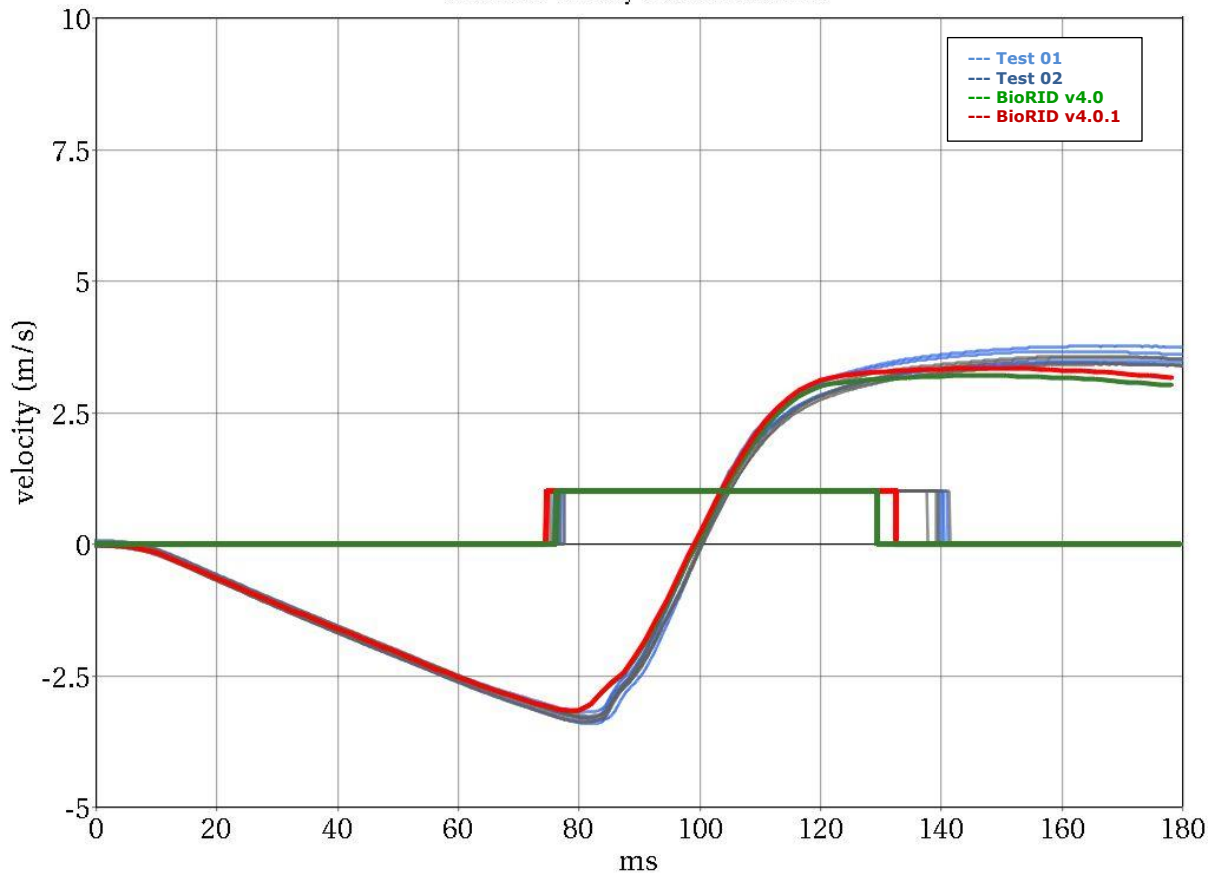


**Page 6 SRA16 pulse**



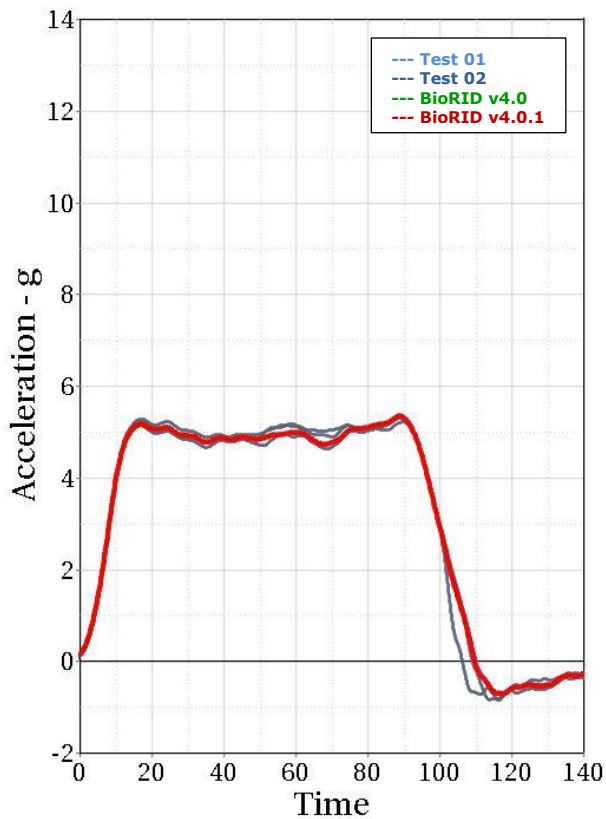
**Page 7 SRA16 pulse**

Rebound Velocity and Contact Time

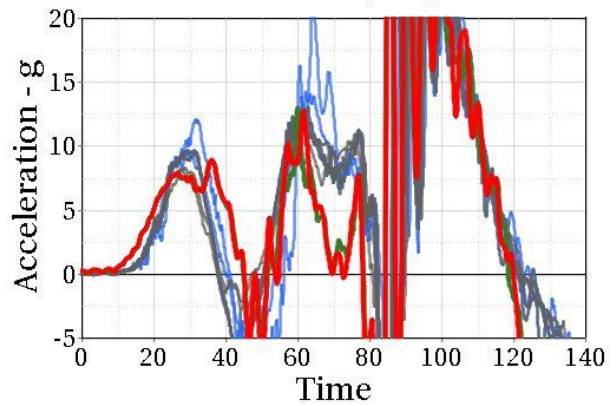


**Page 8 SRA16 pulse**

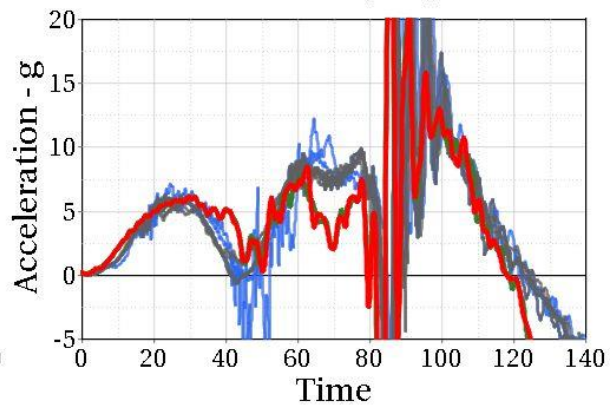
Doppelschlitten HYBER-G Daimle  
SRA16 Puls



Sitzbeschleunigung Oben

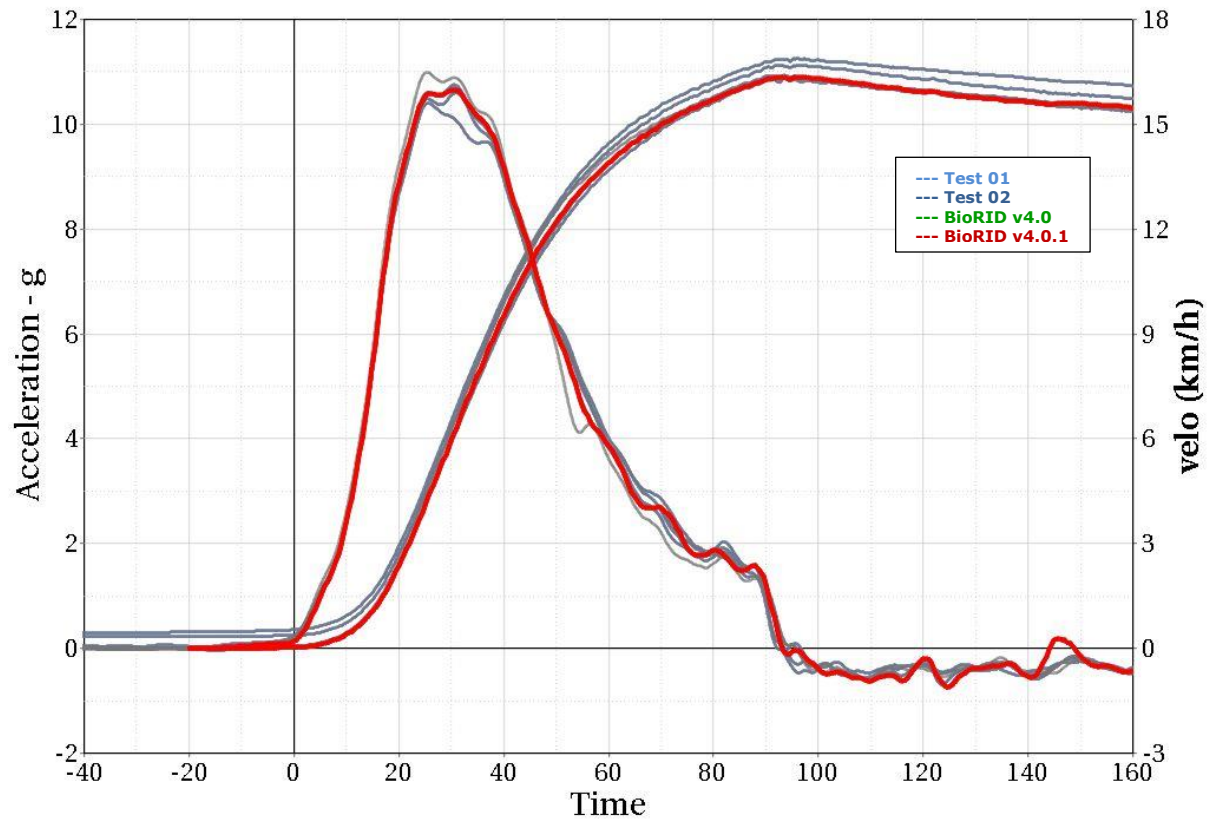


Sitzbeschleunigung Mitte

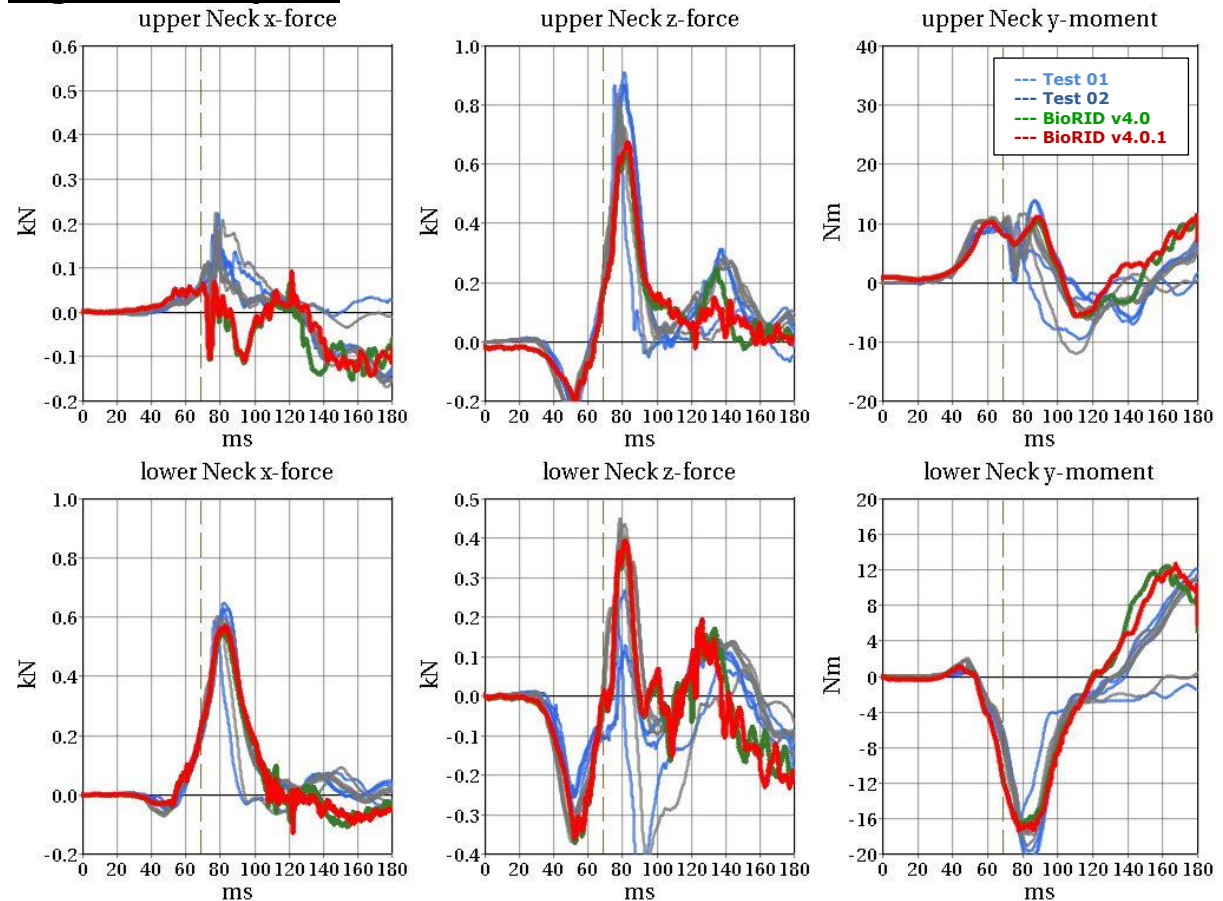


**Page 1 IIWPG pulse**

**Doppelschlitten HYBER-G Daimler  
IIWPG Puls**

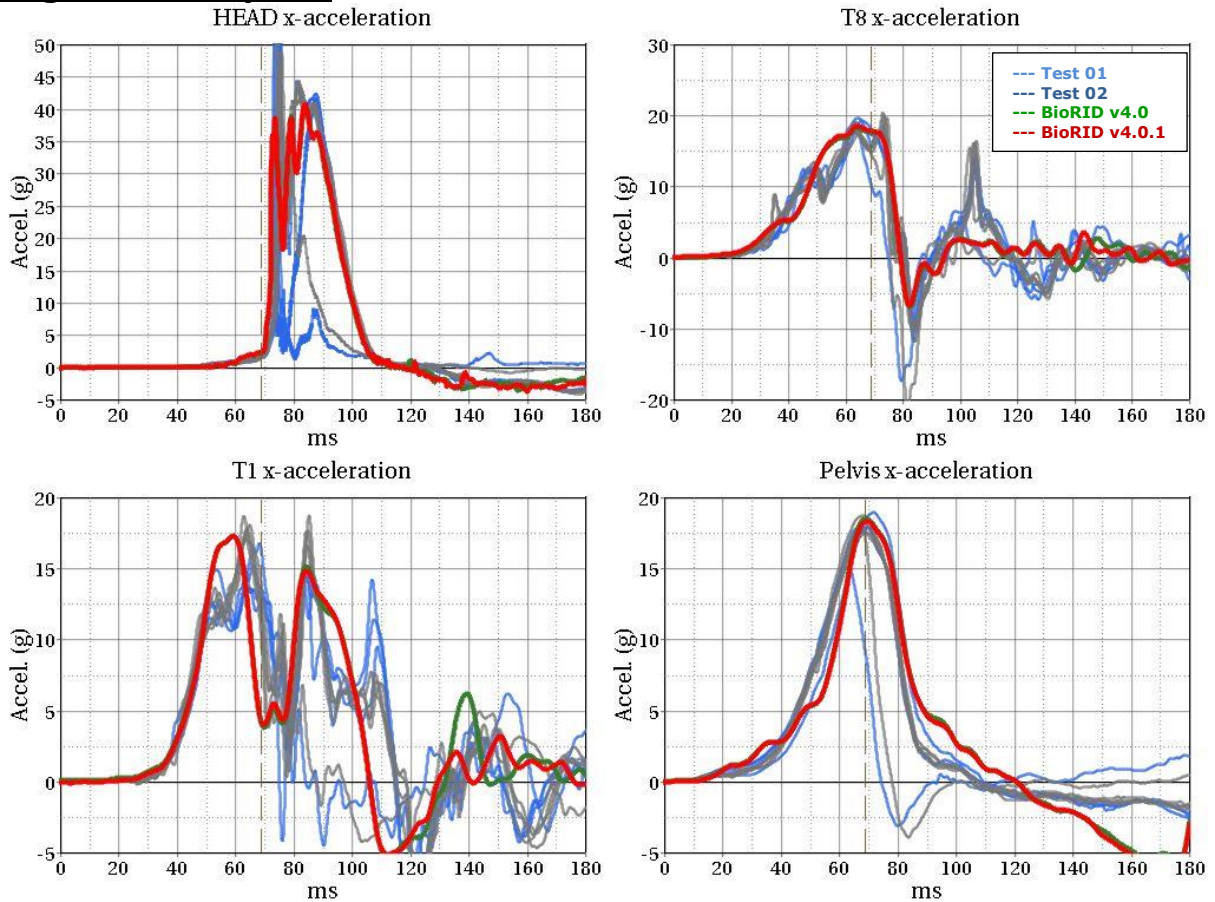


**Page 2 IIWPG pulse**

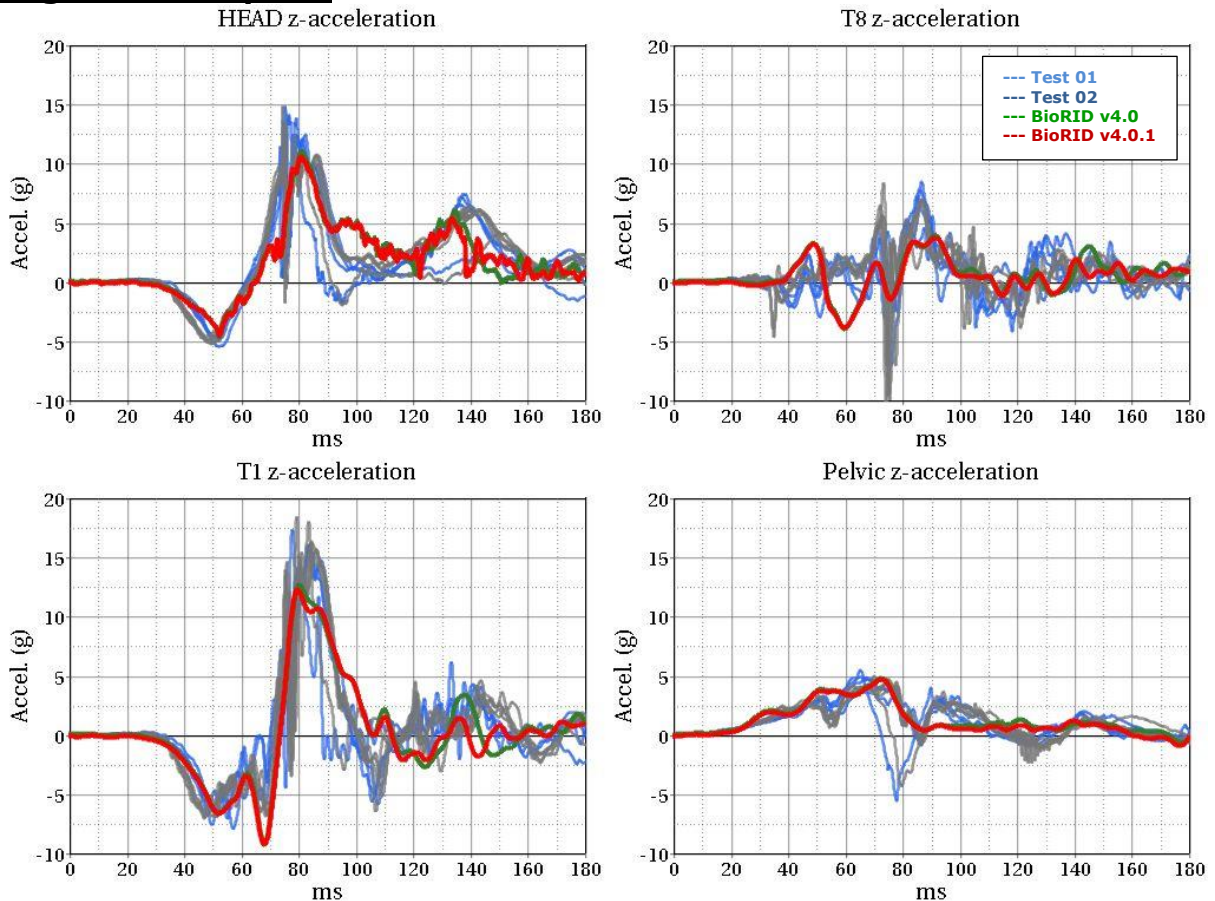




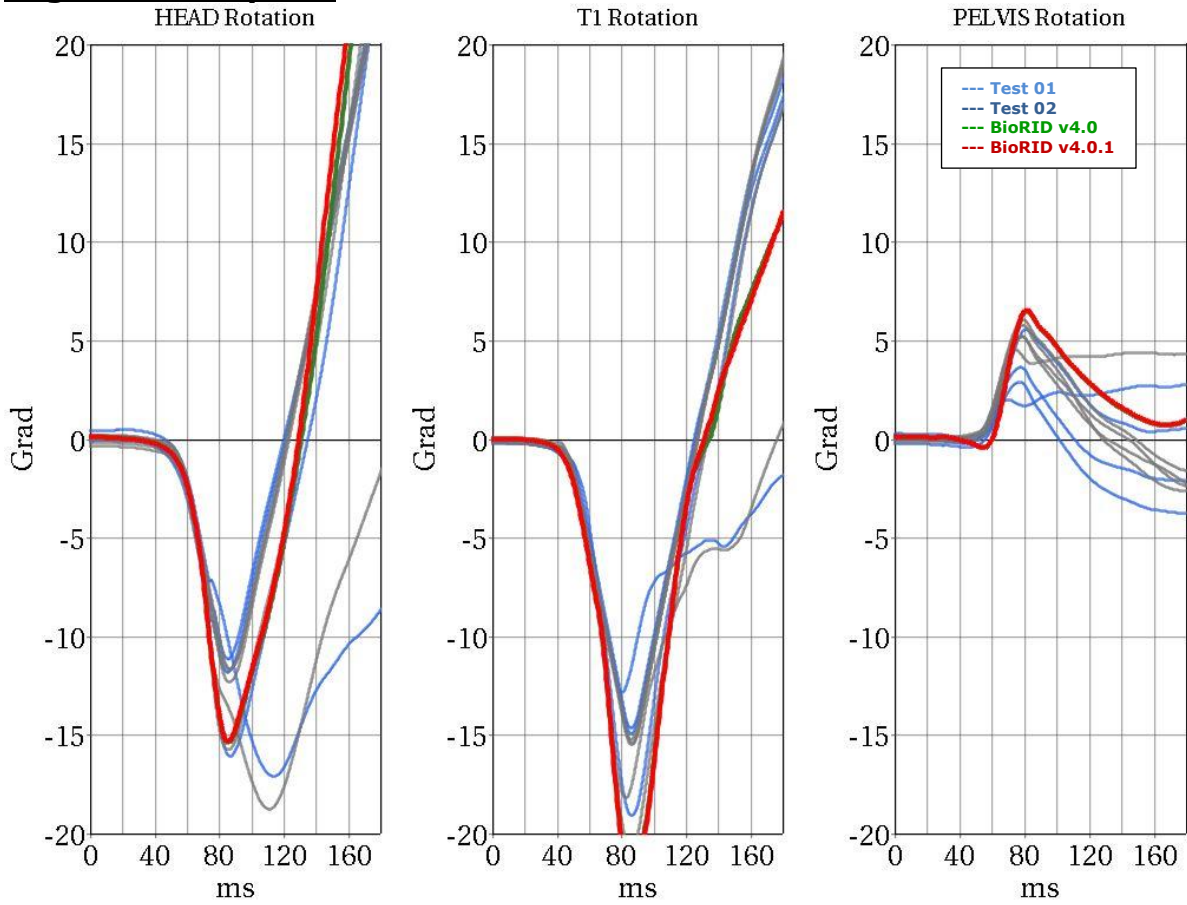
**Page 3 IIWPG pulse**



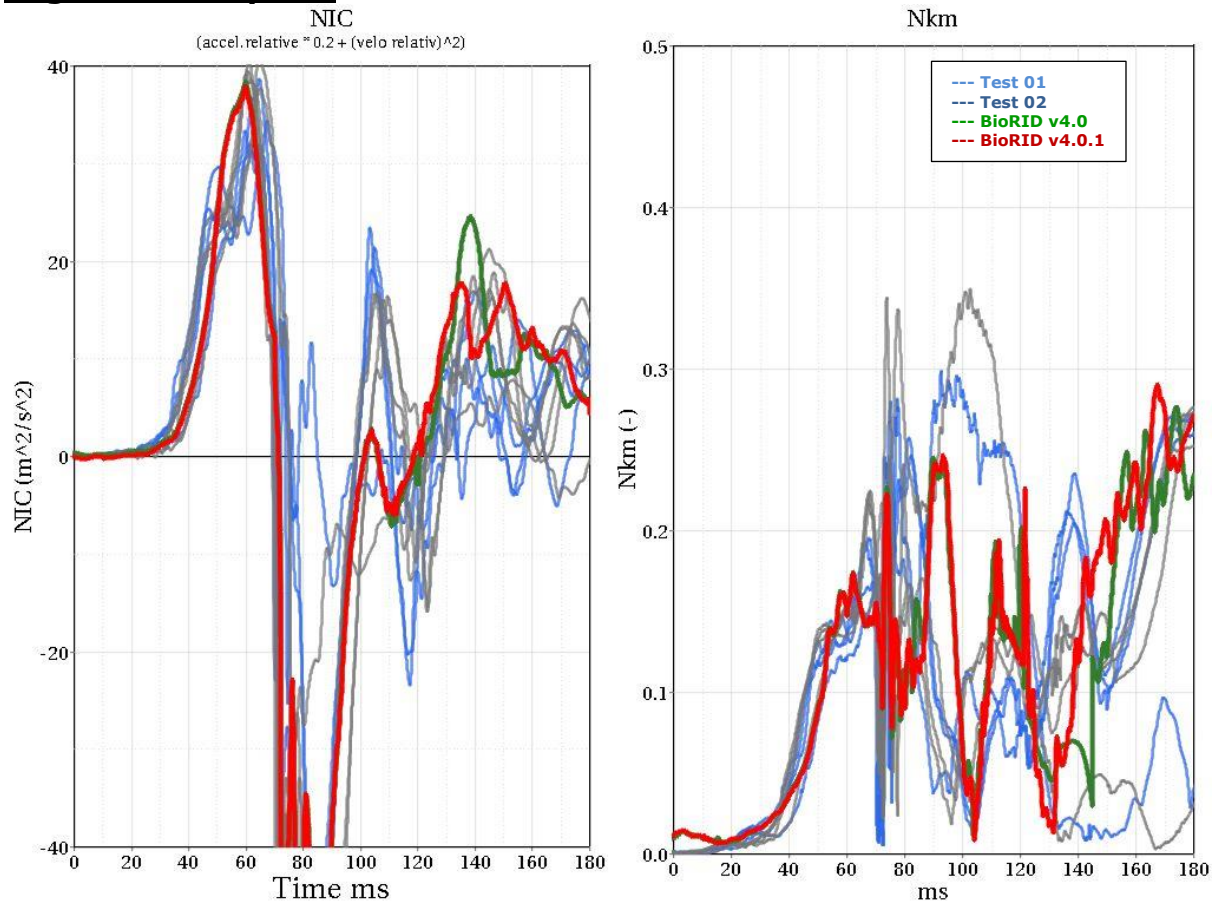
**Page 4 IIWPG pulse**



**Page 5 IIWPG pulse**

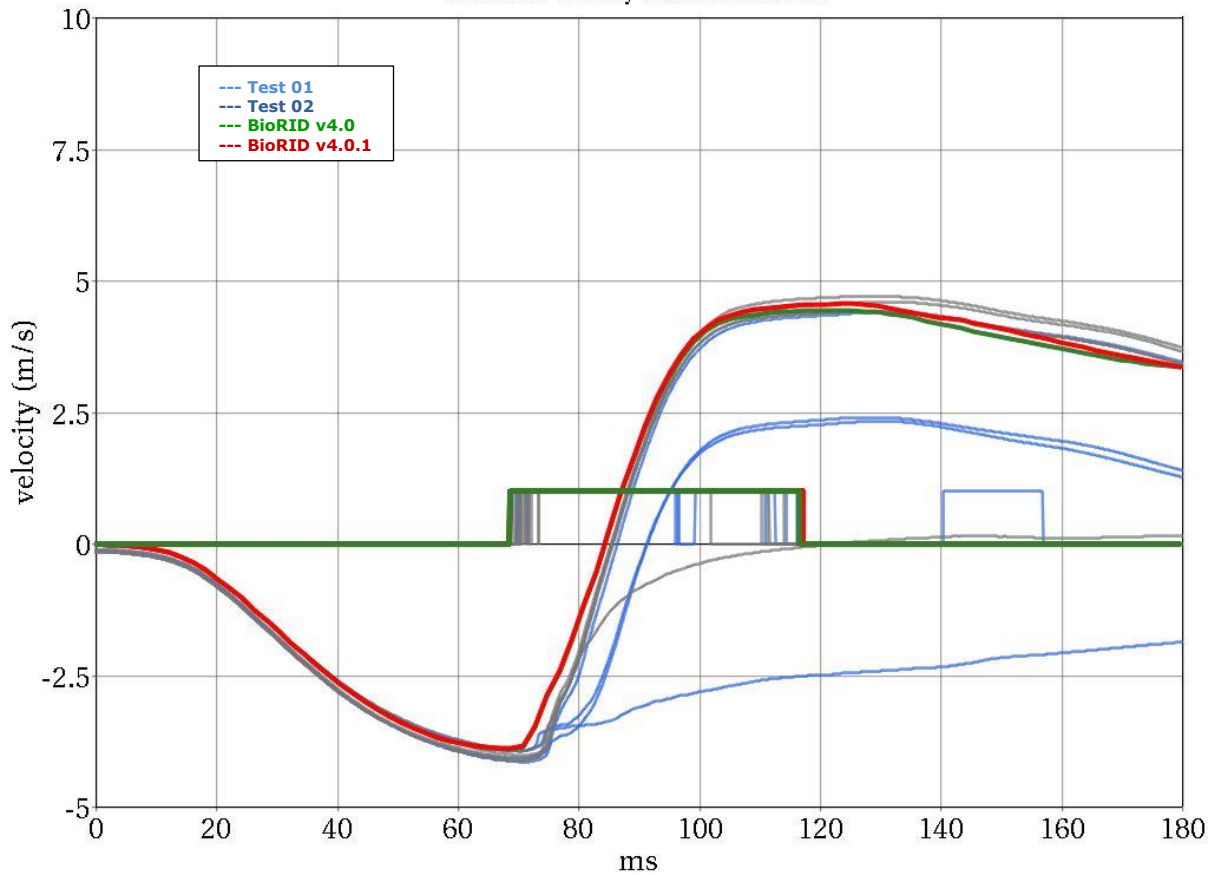


**Page 6 IIWPG pulse**



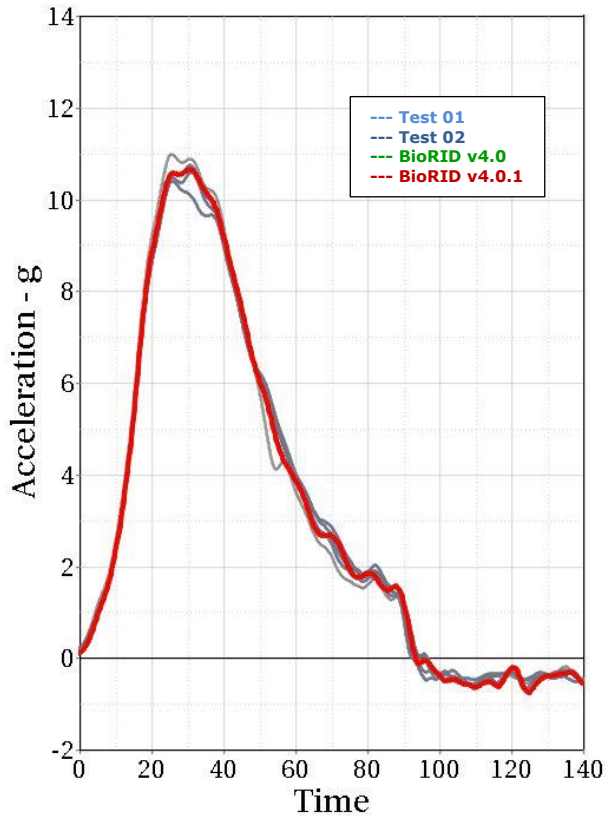
**Page 7 IIWPG pulse**

Rebound Velocity and Contact Time

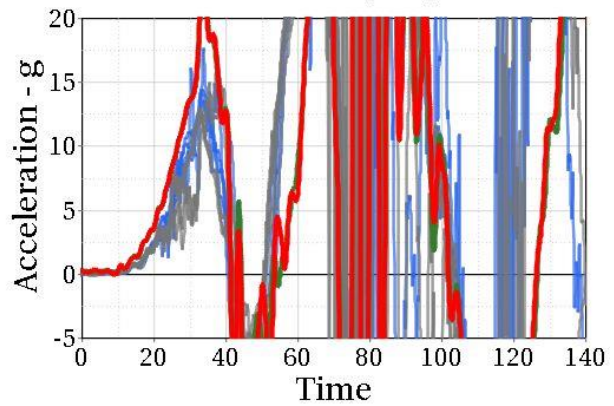


**Page 8 IIWPG pulse**

**Doppelschlitten HYBER-G Daimle IIWPG Puls**



**Sitzbeschleunigung Oben**



**Sitzbeschleunigung Mitte**

